

EDITION 2025

jardinico<sup>®</sup>







jardinico<sup>®</sup>





MADE FOR **SHADE**  
& **OUTDOOR LIVING**  
SINCE **1999**.





At Jardinico Parasols, we are driven by a passion for creating serene outdoor spaces where cherished moments with loved ones can truly flourish. We focus not only to the retail market but also to the project market, where our expertise lies in delivering fully customizable solutions. Whether tailoring colours, integrating branding or adapting designs to specific needs, we work closely with clients to provide bespoke creations for any project.

Based in Harelbeke - Belgium, our headquarters serve as the heart of our operations, encompassing design, distribution and the development of innovative products. As we continue to expand, our vision is to position Jardinico Parasols as the global leader in high-end shade products, setting the benchmark for luxury and functionality in outdoor living.



# OUR HISTORY



As a proud Belgian family-owned company, our roots run deep. For many years, we specialized in textile manufacturing before making a pivotal shift in 1999 to the production of garden cushions.

**1999**

**2000**

In 2000, we expanded into parasols, marking the beginning of our journey in high-end outdoor solutions.

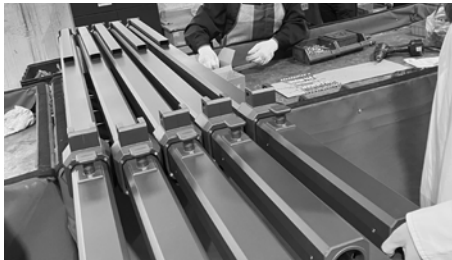

Jardinico evolved in 2015 into two specialized branches, each led by a member of the founding family. Jardinico Cushions, overseen by Bram Vandeputte, continues to produce premium garden cushions with the same dedication to craftsmanship.

Meanwhile, Jardinico Parasols, under the leadership of Bruno Vandeputte, has grown into a premier brand for luxurious shadowmakers.

**2015**





Today, with more than 25 years of expertise in parasols, we offer a comprehensive collection of high-end shade solutions and outdoor designs. From sophisticated umbrellas to dining tables, sunloungers and bespoke accessories, our products seamlessly combine superior quality.

By keeping all cushion and canopy production family-owned at Jardinico Cushions, we ensure that our products stay true to our values and heritage.

## 2025

---

## 2018

3 years later, we expanded our expertise by introducing our first outdoor furniture collection, enabling us to offer a complete outdoor living experience. This addition allows customers to seamlessly combine parasols, furniture and accessories to create a harmonious and stylish outdoor space.





## CARACTÈRE

<b>JCP.1 SERIES</b>	Ambience	12
	Technical	144
<b>JCP.2 SERIES</b>	Ambience	16
	Technical	145
<b>JCP.3 SERIES</b>	Ambience	20
	Technical	148
<b>JCP.4 SERIES</b>	Ambience	26
	Technical	151
<b>JCP.5 SERIES</b>	Ambience	30
	Technical	156
<b>JCP.6 SERIES</b>	Ambience	32
	Technical	157

## ATTITUDE

<b>AZORE</b>	Ambience	38
	Technical	158
<b>ANTEGO</b>	Ambience	42
	Technical	160
<b>LIMA</b>	Ambience	46
	Technical	162
<b>TULI</b>	Ambience	50
	Technical	164
<b>AMALFI</b>	Ambience	54
	Technical	166
<b>MACRAMÉ</b> <sup>NEW</sup>	Ambience	58
	Technical	168
<b>CUBA</b>	Ambience	60
	Technical	170
<b>MOOREA</b>	Ambience	64
	Technical	172



## FURNITURE

<b>TATAMI</b> <small>NEW</small>	Ambience	68
	Technical	180
<b>TONDO</b> <small>UPDATED</small>	Ambience	72
	Technical	182
<b>COMO</b>	Ambience	80
	Technical	186
<b>NOA</b> <small>UPDATED</small>	Ambience	84
	Technical	188
<b>TUGU</b>	Ambience	92
	Technical	194
<b>LEGNA</b> <small>UPDATED</small>	Ambience	96
	Technical	198
<b>NATURE</b> <small>UPDATED</small>	Ambience	100
	Technical	202
<b>MAUROO</b> <small>UPDATED</small>	Ambience	104
	Technical	206
<b>BOLSA</b>	Ambience	110
	Technical	210
<b>MANI</b>	Ambience	112
	Technical	211
<b>DUNE</b> <small>UPDATED</small>	Ambience	114
	Technical	213
<b>LEWIS</b>	Ambience	116
	Technical	212
<b>NESTING TABLES</b> <small>UPDATED</small>	Ambience	118
	Technical	214

## DECORATION

<b>POTTERY</b> <small>UPDATED</small>	Ambience	122
	Technical	218
<b>LIGHTING</b>	Ambience	132
	Technical	226
<b>RUGS</b> <small>UPDATED</small>	Ambience	126
	Technical	224
<b>POUFS</b>	Ambience	130
	Technical	225
<b>DECO CUSHIONS</b>	Ambience	138
	Technical	227
<b>ACCESSORIES</b>	Ambience	136
	Technical	227

## OVERVIEWS

<b>PROJECTS</b>	References	140
<b>CATEGORIES</b>	Umbrellas	228
	Dining chairs	230
	Benches	231
	Bar & counter	231
	Dining tables	232
	Lounge chairs	233
	Sofas	234
	Sunloungers	235
	Daybeds	236
Low tables	236	
<b>CARE &amp; MATERIALS</b>	Maintenance	238
	Accessories	240
	Materials	241





## OUTDOOR SHADE CARACTÈRE COLLECTION

An intuitive view on shade solutions paying tribute to craftsmanship and technical insight was translated into the Caractère collection. A premium outdoor umbrella allowing unlimited shade possibilities and discreet luxury to your garden or terrace. Quality, aesthetics and durability merge together in a modern, chic and demanding world on exterior living.

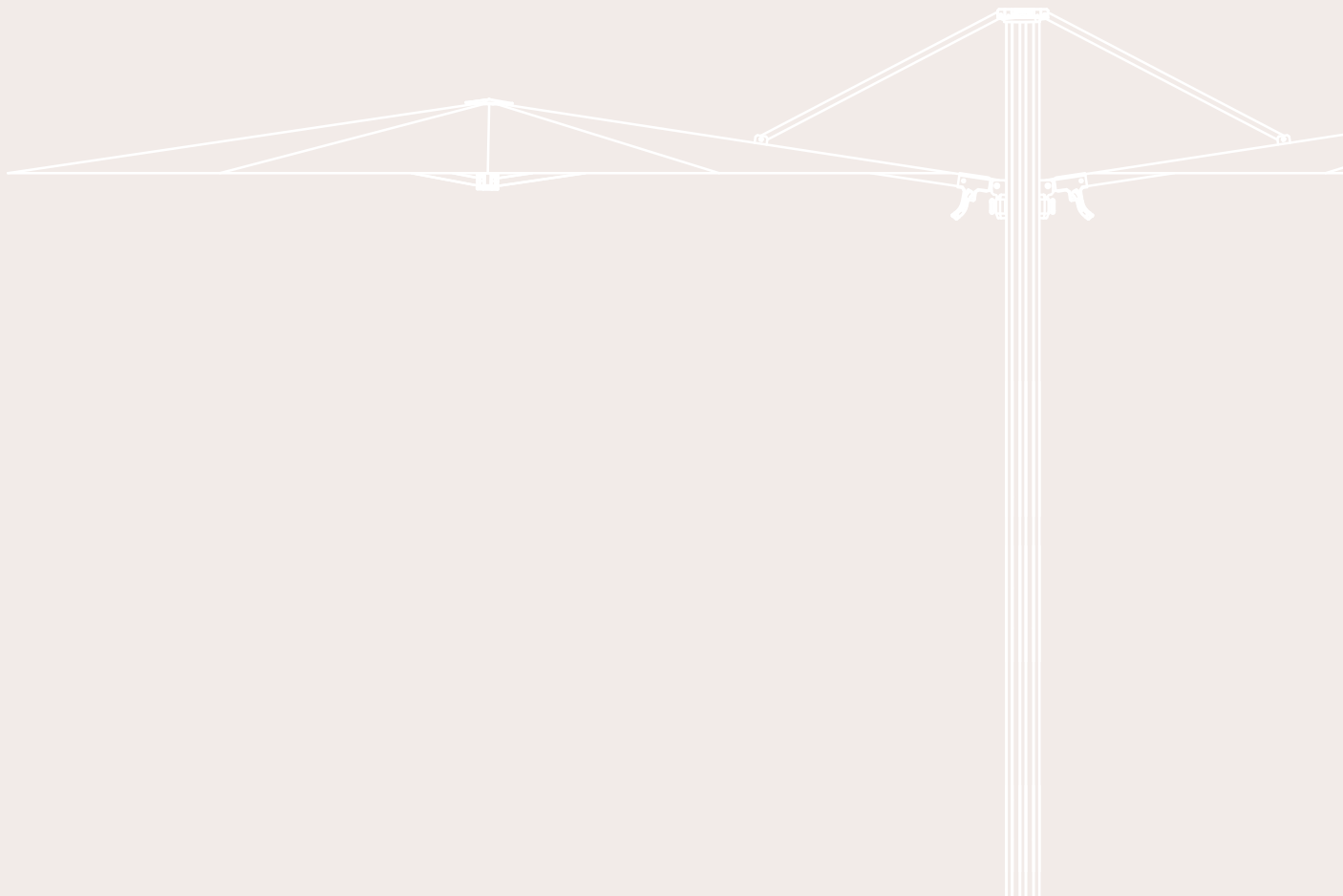







JCP, 102 230 x 230 cm cappuccino & cotton

# JCP.1 SERIES

A perfect match for any project around the world, outdoor umbrellas that blend in seamlessly with the environment. Caractère One Series surprises thanks to its sturdiness.

With a canopy incline of 10°, the umbrella looks enormously flat, drawing attention to its sleek lines with an elegant touch.



JCP. 102 230 x 230 cm alu teak & ice - NERO sunloungers





JCP.1S base 65 kg charcoal



JCP.102 230 x 230 cm alu teak & umber



JCP.202 500 x 500 cm silver & ice







JCP.203 ø 450 cm white & pearl



JCP.201 400 x 400 cm white & pearl

## JCP.2 SERIES

Two series offers outdoor umbrellas that play a central role on your patio. A true eye-catcher, providing up to 25m<sup>2</sup> of shade. Thanks to a telescopic system, you can smoothly open and close the sturdy umbrella at arm height without touching other furniture. Despite their enormous strength, the umbrellas are very mobile due to its base.







JCP. 201 400 x 400 cm silver anodized & mooncrest - MAUROO lounge - NESTING table - WILSON rug







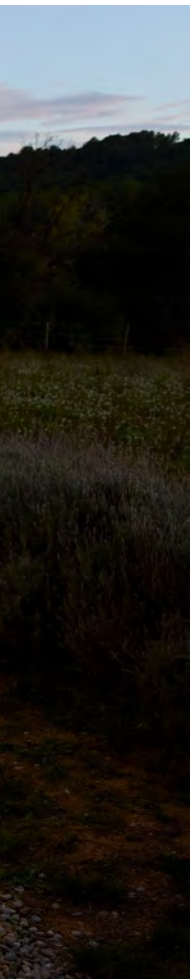

JCP.301 300x300 cm LED charcoal & cotton - NATURE dining - MANI dining chairs



## JCP.3 SERIES

The most iconic series from Caractère. Three Series includes umbrellas that are the heart of your garden, perfect for shelter and protection from the bright sun rays. Every model is extremely convenient to move and operate. By means of the slider, you can easily move this umbrella into every desired position and turn 360° without having to move its base.

This year, we welcome an exciting new addition: a model with integrated LED lighting. Exclusively available in a 300x300 cm size, this umbrella features LED lights elegantly embedded in the ribs, which can be easily operated manually. Powered by solar energy, the lighting creates a warm and inviting ambiance, allowing you to savor those balmy summer evenings with style and comfort.













JCP: 301 300 x 300 cm charcoal & cotton





JCP. 303 ø 350 cm charcoal & cotton - TUGU lounge



JCP. 302 260 x 260 cm charcoal & onyx







JCP-402 425 x 300 cm white & sapphire



# JCP.4 SERIES

Four series is home to a variety of environments all over the world. You may find them in both private use and large projects such as hotels, public buildings, resorts and pool areas.

An exceptionally sturdy outdoor umbrella with an elegant and luxurious appearance. Supported by a 245 kg - 540 lbs base and its dimensions, this series is the perfect marriage between Belgian design, enormous strength and guaranteed quality.











JCP. 403 ø 400 cm charcoal & umbrer



JCP. 401 370 x 370 cm alu teak & cotton



JCP. 402 425 x 300 cm cappuccino & ice



JCP: 501 4 \* 300 x 300 cm alu, teak & pearl







JCP. 501 4 \* 300 x 300 cm alu teak & pearl

# JCP.5 SERIES

Five series has proven to be the ideal model for hospitality. With four separate outdoor umbrellas of 300 x 300 cm on one central pole, this model offers no less than 40m<sup>2</sup> of shade. Each umbrella can be tilted in height and opened individually.

Gutters are available to connect them to each other and enable large areas to have complete, uninterrupted coverage from the sun or rainy weather conditions.







JCP.601 2 \* 300 x 300 cm cappuccino & ice - TUGU lounge



## JCP.6 SERIES

An umbrella that will grace every large outdoor area by its Belgian design. The JCP.601 combines two outdoor umbrellas of 300 x 300 cm that can be opened, closed and tilted in height individually. Together they provide 18m<sup>2</sup> of shade. Thanks to one pole, the space underneath can be used optimally which makes this sunshade ideal for catering projects.





JCP.601.2 \* 300 x 300 cm cappuccino & ice



JCP.601.2 \* 300 x 300 cm charcoal & pearl - MAUROO lounge

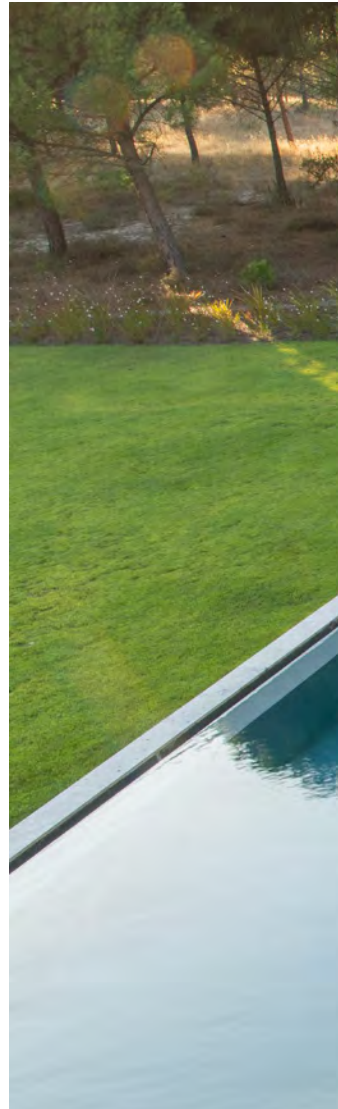







## OUTDOOR SHADE ATTITUDE COLLECTION

The Attitude collection includes outdoor umbrellas to suit everyone's preferences. A mid or free pole umbrella, wood or aluminium and a range of available colours for your canopy.

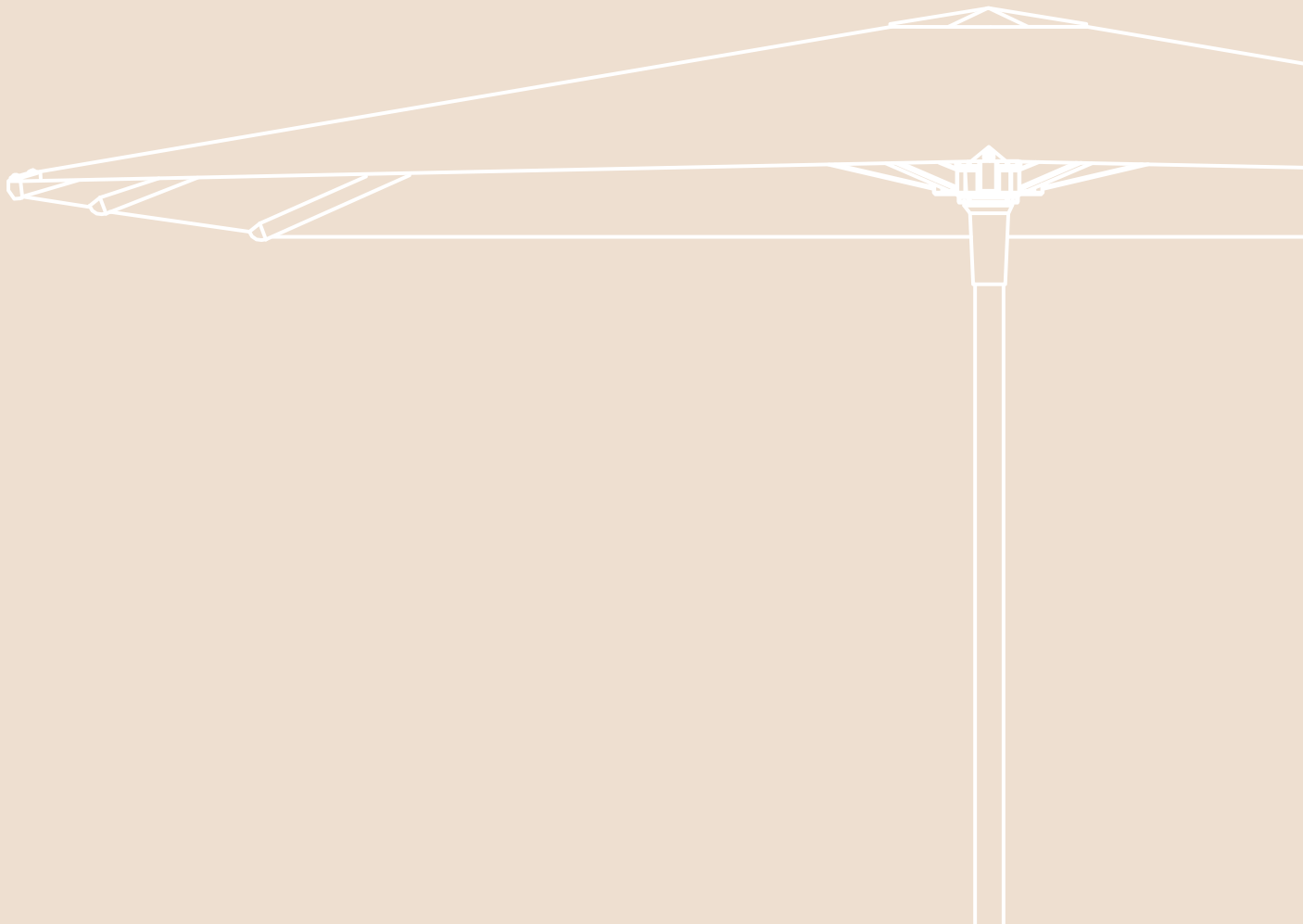







AZORE 300 x 300 cm matt oak & taupe - BOLSA chaise longue - KOBE nesting tables - NOTO lighting

# AZORE

Azore is a free pole umbrella that provides protection on all sunny days. Tilt the umbrella in height with a self-locking tooth belt system at the back of its pole or tilt left and right by means of the crank handle.

The pedal at the bottom of the pole allows you to rotate the umbrella 360° around its axis. Choose a colour combination to your preference and enjoy its sufficient shade on all sunny days, wherever you want on your terrace.







AZORE 300 x 300 cm anthracite & night



AZORE silk grey granite base





AZORE 300 x 300 cm black & black - NATURE dining with LEWIS armchairs





ANTEGO ø 350 cm white & natural with silk grey granite base - BAY poufs



# ANTEGO

Antego offers everything you expect from an outdoor umbrella and does not disappoint. Its operating system allows you to easily move and tilt your umbrella in any desired direction. By means of the pedal at the bottom of the pole, you can rotate the umbrella 360° around its axis.

This outdoor umbrella is developed to complement any outdoor area and give the protection you need all summer long.



ANTEGO 300 x 300 cm linen & heather with concrete base linen - NATURE dining with TONDO dining armchairs - IONA rug





ANTEGO 300 x 300 cm black & steel with silk grey granite base



ANTEGO concrete base linen



ANTEGO 300 x 300 cm alu teak & walnut with black granite base



ANTEGO silk grey granite base with optional extra tiles





LIMA 400 x 300 cm linen & latte



LIMA 400 x 400 cm black & night with silk grey granite base - BAY poufs

# LIMA

The Lima is the largest model in the Attitude collection, combining a sturdy design with an elegant appearance. Despite its impressive size and robust build, this umbrella is remarkably easy to use. With the convenient crank handle, opening the umbrella is effortless.

Equipped with a rotation pin, the Lima allows for smooth 360° rotation around its axis, ensuring you can provide shade throughout the day without ever needing to move the umbrella.











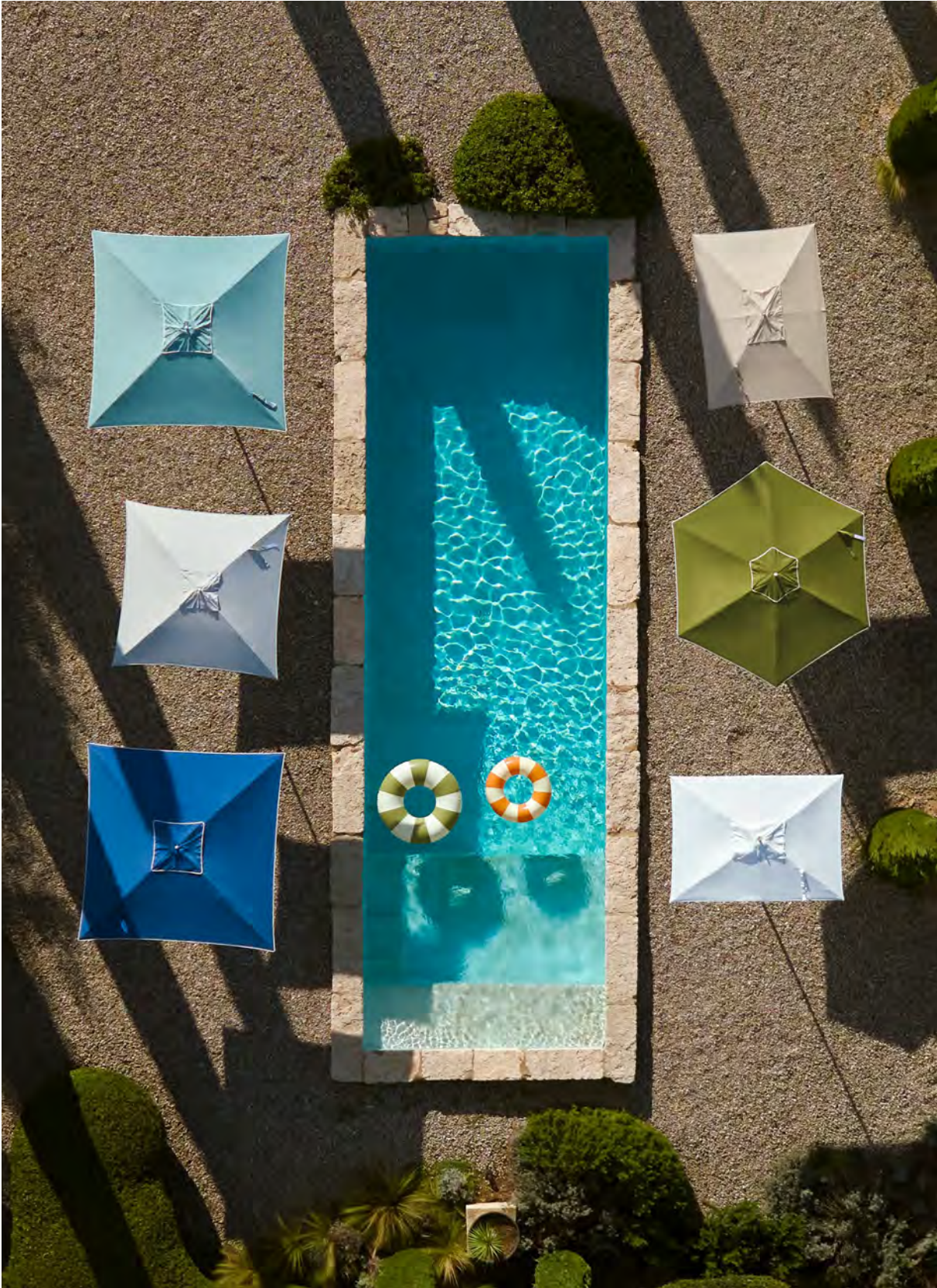

TULI 240 x 240 cm white & spa with bone piping, TULI 200 x 200 cm white & cloud, TULI 240 x 240 cm linen & latte, TULI ø270 cm white & kale with bone piping, TULI 150 x 210 cm alu teak & natural



# TULI

Despite its lightweight nature, the Tuli stands firm and steady, thanks to its dual locking pins that ensure stability, even in gusty winds.

Built for durability, the Tuli features flexible fiberglass rib ends that enhance its resilience. Its convenient tilt function allows you to angle the umbrella effortlessly, offering shade even when the sun is low on the horizon.

Available in neutral and classic colour combinations, as well as playful options with contrasting trims, the Tuli umbrella brings both style and functionality to your outdoor space.



TULI ø 270 cm white & kale with bone piping, TULI 150x210 cm alu teak & natural



TULI 240 x 240 cm white & spa with bone piping







TULI 240 x 240 cm linen & latte



TULI 240 x 240 cm white & spa with bone piping



TULI round base white





AMALFI 300 x 300 cm alu teak & arctic



AMALFI ø 300 cm anthracite & night, 300 x 300 cm anthracite & gris nature, 250 x 250 cm alu teak & natural with LUCCA heavy bases anthracite

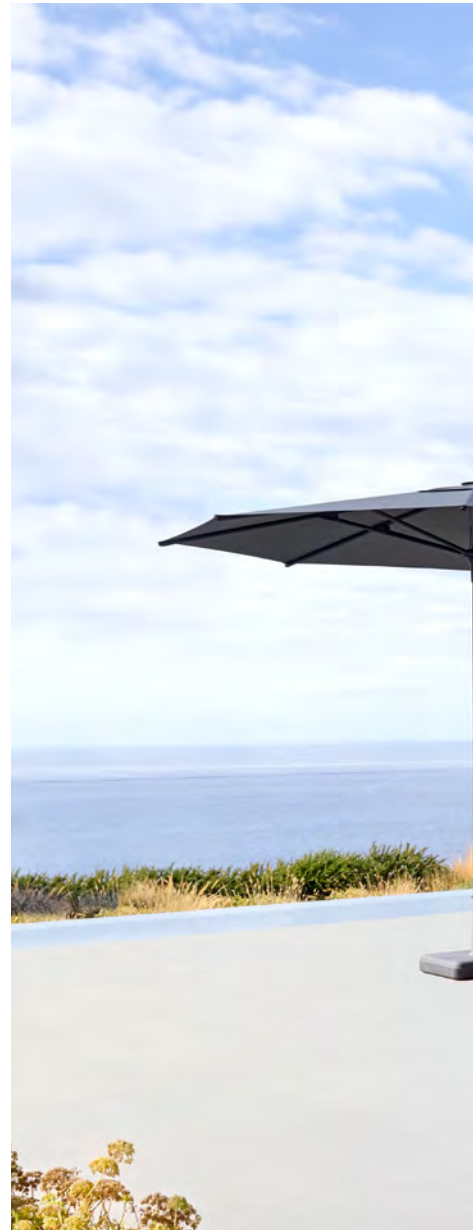

# AMALFI

The perfect intermediate, fitting both smaller and larger areas. A design that spreads a luxurious appearance and gives the ultimate feeling of comfort, thanks to its push-up system.

Amalfi shows very slim, elegant lines and fits seamlessly into the design of modern urban landscapes, leisure resorts and private homes.







AMALFI 250 x 250 cm black & night with ELBA medium charcoal - TUGU lounge

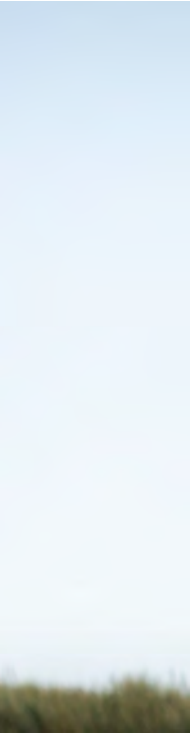

AMALFI 250 x 250 cm black & night



AMALFI ø 300 cm linen & steel





MACRAMÉ ø 250 cm teak & naturel, ø 250 cm teak & sand

MACRAMÉ ø 250 cm teak & natural, ø 250 cm teak & sand



# MACRAMÉ

This parasol combines timeless charm with a touch of playfulness, featuring a stylish wooden frame and playful fringes that add a delightful flair to any setting.

Available in two elegant colour options, it's the ultimate eye-catcher for terraces, beach bars or any outdoor space looking for a statement piece.





CUBA ø 350 cm eucalyptus & natural with ELBA base heavy white

# CUBA

Cuba is a timeless classic in the Attitude collection. It shows wood craftsmanship thanks to its frame made of eucalyptus wood with stainless steel, corrosion proof parts.

This umbrella shows its beauty around the globe and is developed to withstand tough, windy conditions in tropical climates.



CUBA ø 350 cm eucalyptus & taupe





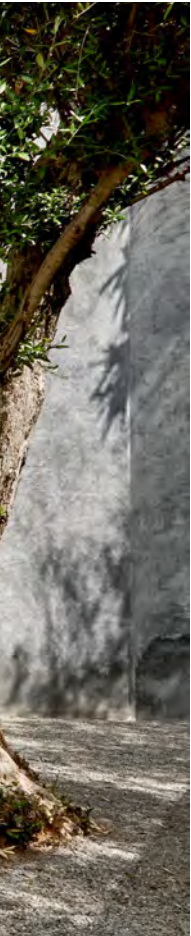

CUBA 300 x 300 cm eucalyptus & white with ELBA base heavy white







MOOREA 300 x 300 cm teak scratched & taupe



MOOREA 300 x 300 cm teak scratched & taupe - TECCA sunloungers



# MOOREA

An umbrella that is constructed to perform faultlessly and will grace your garden by its sleek and elegant touch. Moorea is finished by a scratched teak frame for a natural and rough finish, including a cord pulley to smoothly open and close the umbrella.

You are able to enjoy the perfect shade for many years to come because of a high performance and protective canopy. Moorea features a heavy duty frame with a diameter of 55 mm and is available with multiple base options.



MOOREA 300 x 300 cm teak scratched & natural with ELBA heavy bases white - NOA sunloungers - DUNCAN teak blocks





## OUTDOOR LIVING FURNITURE COLLECTION

Our aim is to create a place to unwind, where you feel the sun and can relax. There are unlimited possibilities, a collection for every style through a wide range of models, colours and finishes.

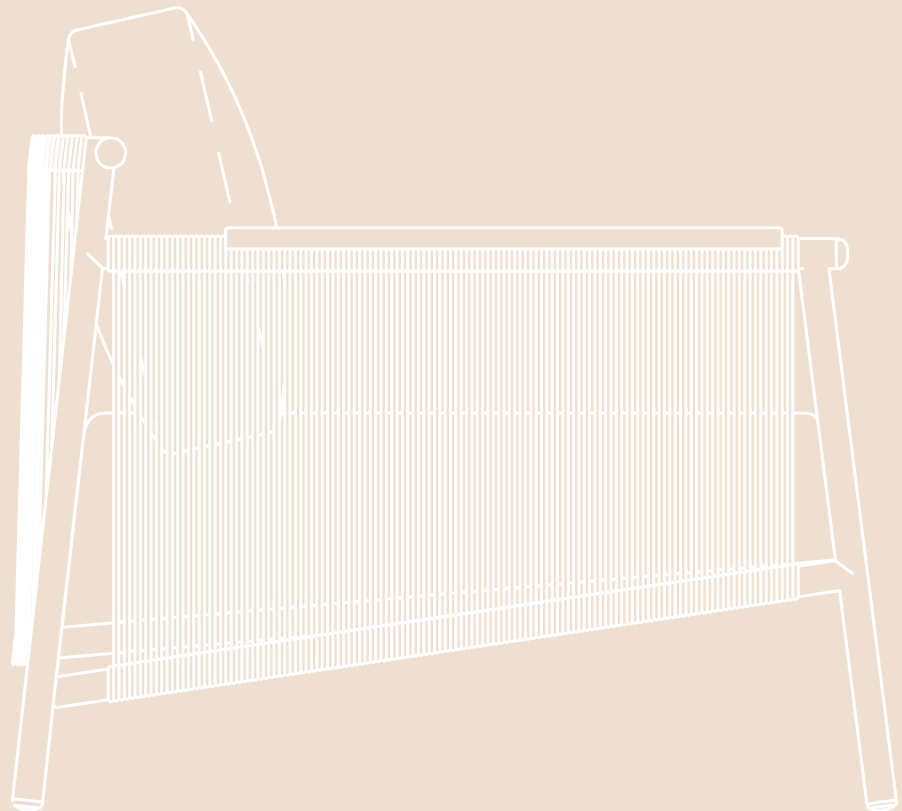





TATAMI lounge chair 1S peacock



TATAMI lounge chair 1S matcha





# TATAMI

The Tatami Collection offers a fully upholstered modular sofa set with a teak frame, designed to adapt seamlessly to your style and space. Create countless configurations with the modular pieces and personalize your lounge set by selecting from our extensive fabric range. Whether you prefer a timeless look or a bold statement by mixing different fabrics, the choice is yours.

The rounded shapes of the Tatami Collection invite you to relax in comfort and style, making it the perfect setting for hours of cozy lounging. Transform your outdoor space with a design that combines versatility, sophistication and warmth.



TATAMI lounge chair 1S bubblegum, sofa 2S right arm seaweed, claybed seaweed, COMO nesting coffee tables - COMO nesting side tables - COCO rug 400 x 600 cm





TATAMI lounge chair 1S bubblegum, sofa 2S right arm seaweed, daybed seaweed - COMO nesting coffee tables - KOBE nesting side tables - COCO rug 400 x 600 cm









TONDO dining armchair pampas



TONDO lounge chair 1S pampas



# TONDO

Step into a world of mesmerising design with the Tondo collection, where each piece weaves a story of comfort and versatility.

The hallmark of this collection lies in the craftsmanship of a thick, multi-coloured 30mm rope. It is carefully intertwined into a visually captivating pattern that defines the essence of the entire collection.

This striking rope motif is complemented by the sturdy yet sleek powder-coated aluminium frame in a serene linen shade, which adds a touch of contemporary allure to the whole assembly.



TONDO dining armchairs pampas - LEGNA dining table 320 x 100 cm teak & earth - IONA rug 300 x 400 cm





TONDO dining armchairs pampas - LEGNA dining table 320 x 100 cm teak & earth - IONA rug 300 x 400 cm - TONDO lounge chairs 1S pampas - KOBE nesting side table









TONDO daybed pampas



TONDO sofa 3S pampas & side table teak - COMO nesting side tables - DECO cushions petrol & peacock





TONDO sofa island pampas & coffee table teak



TONDO lounge chair 1S pampas - DECO cushion papaya - WILSON rug 300 x 400 cm oyster







TONDO modular organic island, 2.5S pampas & coffee table teak - BAY pouf large peacock - WILSON rug 280 x 390 cm oyster  
DECO cushions papaya, wave, peacock & matcha



TONDO coffee table teak



TONDO daybed pampas - NOA sofa side table teak





# COMO

Designed with a keen eye for fluidity, this collection showcases graceful lines and embraces the beauty of organic, rounded forms.

Crafted from a unique blend of lime and concrete, each item is meticulously hand-applied with a spatula, resulting in a distinctive texture that marries the ruggedness of concrete with the smoothness of silk.

The material not only exudes a luxurious and silky texture but also boasts exceptional water repellency and waterproof properties, ensuring durability against all weather conditions.



COMO organic dining table ø 160 cm - DUNE dining armchairs - COCO rug ø 300 cm



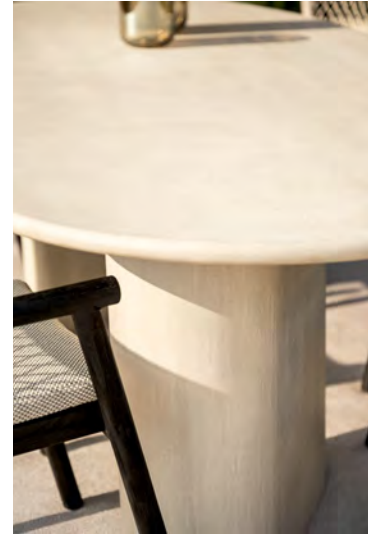

JCP.302 charcoal & onyx - COMO organic dining table 260 x 120 cm - NERO dining armchairs - WILSON rug 280 x 390 cm greige - ANTICO pots bronzo





COMO nesting coffee tables - TATAMI sofa 3S seaweed & daybed seaweed  
COCO rug 400 x 600 cm



COMO nesting side tables







# NOA

Noa collection, designed by Enrique Marti, establishes an oasis of tranquillity. Creating a calming, serene environment is the aim of this collection and inspired us also on the name of this collection. Noa - Noach which means rest and peace.

Characterised by its curving, the framework is made of natural teak that pays homage to old craftsmanship. The feeling of being close to nature continues thanks to the hand woven strap with a subtle touch of green.



NOA sofá 3S & ottoman brulé, coffee table teak - COCO rug 250 x 350 cm - DECO cushion scarlett & cotta





NOA dining table 270 x 120 cm, dining chairs & armchairs brulé & truffe - CUMINO fiore set ruggine





NOA dining armchairs brulé









MACRAMÉ ø 250 cm teak & natural - LUCCHA heavy base hazel - NOA bar table 200 x 100 cm teak - DUNE barchairs - YARA rug ø 300 cm



DUNE barchairs - NOA bar table 200 x 100 cm - YARA rug ø 300 cm









NOA chaise longues brûlé - COCO rug ø 300 cm



NOA ottoman brûlé







# TUGU

Tugu collection unveils a new classic that seamlessly connects its design to the surroundings. Unique outdoor furniture pieces with soft contours setting out a balance between a modern and contemporary design with a classic, yet inviting look.

True craftsmanship is brought to life through hand woven wicker portraying an elegant landscape and focusing attention on all details.

JCP:303 ø 350 cm charcoal & cotton - TUGU sofa 1S, 2S, 3S linen, coffee table ø 90 cm & ø 120 cm, side table ø 45 cm sable teak



TUGU lounge chairs 1S linen





TUGU daybed linen - DECO cushions cotta







JCP102 cappuccino & coiton - TUGU daybed linen, side table taupegrey, pottery set - DECO cushions cotta & turtle - COCO rug ø 300 cm



TUGU coffee table ø 90 cm taupegrey & side table ø 45 cm teak





LEGNA lounge chair 1S cream, side table - DECO cushion corn



LEGNA dining table 320 x 100 cm teak & earth - TONDO dining armchairs pampas - IONA rug 300 x 400 cm



LEGNA dining table 320 x 100 cm sable teak & taupegrey - LEGNA dining armchairs cream - WILSON rug 280 x 390 cm oyster

# LEGNA

We pay tribute to true craftsmanship that merges perfectly with nature's colours and materials. Perfectly suited for both rustic and modern spaces, this collection provides maximum comfort while elevating your outdoor aesthetic.

Choose from three types of 12mm-thick ceramics for a sleek and refined look that balances beauty and durability.





LEGNA chaise longues cream & side table sable teak - DECO cushion corn





JCP301 charcoal & cotton - LEGNA lounge chairs 1S, 2.5S, 3S & coffee table - WILSON rug 250 x 350 cm oyster







NATURE dining table 350 x 120 cm almond & teak



JCP301 LED charcoal & cottonNATURE dining table 350 x 120 cm & bench 350 x 42 cm almond & teak - MANI dining armchairs



# NATURE

The beauty of raw, solid teak makes every piece unique with an irregular touch. All dining tables and benches are carried by a sturdy powder coated aluminium frame for extra support.

The collection includes a normal dining table, but also a low dining concept. These are slightly lower than a traditional dining setting and create a relaxed posture allowing you to enjoy hours of dining that overflows in an endless evening full of joy.



NATURE dining table 350 x 120 cm & bench 350 x 45 cm almond & teak







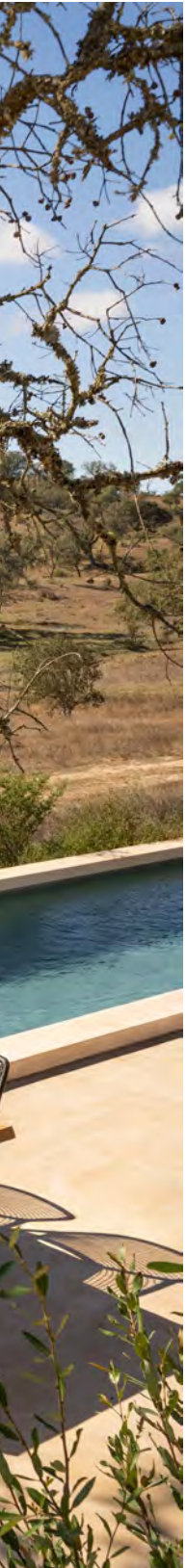

NATURE low dining table 280 x 120 cm black & teak - LEWIS low dining armchairs vanilla







MAURO modular table taupe grey



MAURO sofà 25 charcoal & smoke grey



MAUROO chaise longue with teak table, long sofa with teak table, sofa 2S smoke grey, coffee table teak - DUNCAN teak block, WILSON 250x350 cm oyster

# MAUROO

Mauroo comes with unlimited possibilities, adapted to your choice and preference. Its modular design and versatile use are translated into a unique concept that fits every patio. Choose between two colours for the frame and cushions.

Developed to exceed all expectations, the collection comprises high-performance outdoor cushions with large volume and is supported by an elegant aluminium frame.





CUBA ø 300 cm eucalyptus & natural - MAUROO chaise longues white & vanilla with tables bianco & teak - KOBE nesting tables - NOTO lighting







MAUROO sofa 2S, long sofa with table & modular table bianco - NESTING table ø 90 cm white & bianco - COCO poufs 50 x 40 cm & 100 x 40 cm - DECO cushions wave, petrol & mint - COCO rug 300 x 400 cm - WILSON rug 200 x 300 cm greige









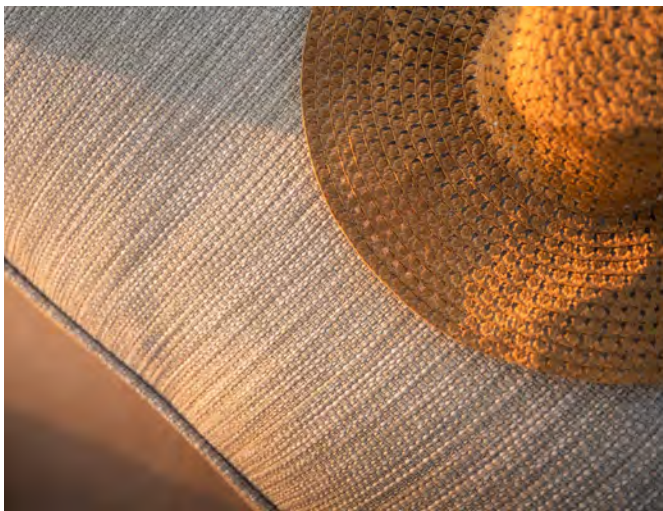

BOLSA 125 cm azul with protection cover



JCP:102 230 x 230 cm cappuccino & umber - BOLSA 125 cm azul & 170 cm matcha - TONDO side table teak



BOLSA 150 cm celadon - KOBE nesting side tables

# BOLSA

Playfulness, comfort and cosiness are the ingredients of Bolsa. Whether you use it to unwind by the pool or as an eye-catcher for your outdoor space, this beanbag is always a good idea.

Choose the short model or settle for the long version for a chilly afternoon by the pool.





MANI footstool



MANI dining armchair-brulé



MANI lounge chair 1S brûlé - DECO cushion amaretto



TULI linen & latte - MANI lounge chairs 1S & footstool - KOBE nesting side tables - DECO cushion amaretto

# MANI

Crafted to elevate your dining and lounging experiences, this collection comprises a dining chair, lounge chair and complementary footstool.

This meticulous weaving not only adds a touch of artisanal charm but also provides a comfortable and supportive seating experience. The almond-coloured rope is elegantly framed by a powder-coated aluminum structure in a matching shade.





DUNE barchairs - NOA bar table 200 x 100 cm



# DUNE

Dune - where comfort meets coastal charm. Inspired by the serenity and calmness of the shoreline, the Dune Chair is a masterpiece that seamlessly blends natural aesthetics with unparalleled comfort.

A natural teak frame combined with a hand woven linen rope makes the chair versatile for every setting. Whether placed on a sunlit patio, in a cozy reading nook, or around a dining table, the Dune Chair enhances the ambiance with its understated elegance.



DUNE dining armchair







NATURE low dining table 280 x 120 cm black & teak - MANI low dining armchairs vanilla



MANI low dining armchairs vanilla



# LEWIS

The Lewis Collection combines stylish design with unmatched comfort, making it a perfect addition to your dining experience. Featuring a regular dining chair and a low dining armchair, this collection pairs seamlessly with the Nature (low) dining table for a cohesive and sophisticated look.

Crafted with black synthetic seagrass for a natural aesthetic and supported by a sleek black aluminum frame, the Lewis chairs offer both durability and timeless appeal.





KOBE nesting side tables - TONDO lounge chair 15 pampas



NESTING side tables white & taupegrey, white & teak



TARO coffee table round & organic - TONDO 1S, 3S, daybed - DECO cushions ray & amaretto - WILSON rug

# NESTING TABLES

Enhance the ambiance of your lounge area by incorporating a stylish set of accent tables, adding that perfect extra touch and creating a functional space.

Explore our nesting tables that offer a play of shapes in teak, as well as in aluminium and ceramic.







## OUTDOOR LIVING DECORATION COLLECTION

No outdoor area is complete without a striking accessory. An outdoor lantern to set a mood once the sun sets, a heavy duty outdoor rug or some poufs that match your furniture cushions perfectly. Choose any size, material or fabric that suits your style and let our range of decoration items add the finishing touch you envisioned to your garden and terrace.







CUBO divider small panna, square large ombra & panna, divider large ombra



CUMINO conico set of 3 panna

# POTTERY

Each planter is made with natural materials, combined with FRP. All designs and shapes offer the finishing touch to every patio. Enjoy yours for many years to come due to its weather and UV resistance.



Pietra finishing



ANTICO anfora & vaso pistachio



CARTELLO marone





CUMINO conico set of 3 ruggine



TERRA alto macchiato





TERRA cerchio macchiato



TERRA classic low macchiato & sabbia, mid nero & macchiato - BAY pouf papaya & wave



CURVO set caffè



CUMINO calice panna





COCO rug







TATAMI lounge chair 1S bubblegum, sofa 2S right arm seaweed, daybed seaweed, daybed seaweed - COMO nesting coffee tables - KOBE nesting side tables -  
COCO rug 400 x 600 cm



NINO rug 300 x 400 cm - TATAMI lounge chair 1S amaretto - KOBE nesting side table - DECO cushion ray

# RUGS

A beautiful rug creates a warm environment, even outside in your garden. Go for a chunky one with thick rope or with long hairs for your lounge and a tighter rug for your dining area.





YARA rug ø 300 cm







WILSON rug greige



LEGNA dining table 320 x 100 cm teak & earth, TONDO dining armchairs - IONA rug 300 x 400 cm



AMALEI 300 x 300 cm alu teak & arctic - TATAMI lounge chair 1S peacock - DUNCAN teak block 40 x 30 cm & 70 x 30 cm, YARA rug ø 300 cm



IONA rug seal





BAY pouf medium bubblegum & small celadon

# POUFS

The collection offers a range of sizes from round to square and from small to large poufs. Choose a material, colour and finish to your preference and complete your setting.



BAY pouf large celadon & blade piping - BAY pouf small frappé



BAY pouf large celadon & blade piping



COCO pouf round small & large, square small





NOTO conic small & large natural



NOTO oval small & large black



# LIGHTING

Nothing better than a warm outdoor light to make summer evenings more cozy. Our lanterns in teak or aluminium and solar-powered LED lights provide a pleasant atmosphere every single time.



NOTO oval small black



SOLORE sphere set natural



SOLORE sphere set natural





ARCO small

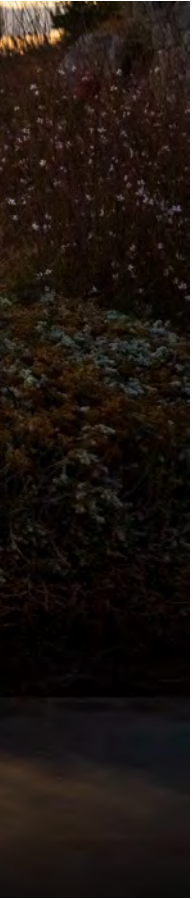

ARCO small & large



SOLORE cube set taupe





ANTIBES winecooler teak



ANTIBES winetub teak



PRANA baskets small & large



# ACCESSORIES

Nothing better than a warm outdoor light to make summer evenings more cozy. Our lanterns in teak or aluminium and solar-powered LED lights provide a pleasant atmosphere every single time.





DECO cushion 50 x 30 cm papaya



TATAMI lounge chair 15 matcha - KOBE nesting side table - DECO cushion mint



DECO cushion papaya, peacock & wave

# DECO CUSHIONS

A few outdoor deco cushions create extra cosiness in your garden. Choose energising colours to create a pop of colour or go for earth tones for a more chic and relaxing vibe.



TATAMI lounge chair 1S bubblegum - TATAMI deco cushions ø 40 cm cotta & bubblegum



# PROJECT REFERENCES

**Fairmont Royal palm** - Marrakesh - Marrocco  
**Sea lounge** - Porto-Vecchio - Corsica  
**Cove beach** - Dubai - UAE  
**Limonade Maillot** - Paris - France  
**Kempinski** - Aqaba - Jordan  
**Jules Bar** - Kortrijk - Belgium  
**Radisson Blu** - Wiesbaden - Germany  
**Limonade Maillot** - Paris - France  
**Wittamer** - Brussels - Belgium  
**Kempinski Hotel** - Bruges - Belgium  
**Blue Origin** - Deerlijk - Belgium  
**Blue Buddha Beachclub** - Knokke - Belgium  
**Collin's Beach** - Knokke - Belgium  
**Bar d'O Beach Club** - Knokke - Belgium  
**Blue Buddha beach club** - Knokke - Belgium  
**Kruisheren Hotel** - Maastricht - The Netherlands  
**Country Club** - Samois Sur Seine - France  
**Koevert** - Avelgem - Belgium  
**Le Couvent des Minimes** - Mane - France  
**Hôtel Julien** - Fouday - France  
**Peninsula** - Paris - France  
**Golf Up** - Grimaud - France  
**Nørgaard** - Hornbaek - Denmark  
**La Plage** - Casadelmar - Corsica  
**Yacht Club** - Porto Montenegro  
**Botanic Sanctuary** - Antwerp - Belgium  
**La Gazelle d'Or** - Tunesia  
**Parkhotel** - Kortrijk - Belgium  
**Domaine de coyeux** - Beaumes-de-Venise - France  
**Royal Hideaway Corales** - Tenerife - Spain  
**Eyebar** - Hong Kong - China  
**Honi Honi Bar** - Hong Kong - China  
**Wooloo Mooloo** - Hong Kong - China  
**Retreat & Spa** - Maledives  
**Berjaya Hotel** - Kuala Lumpur - Malaysia  
**Mulia Hotel** - Bali - Indonesia  
**Age-Hassim Hill** - Singapore  
**Joe's Café** - Doha - Qatar  
**Utopia** - Abu Dhabi  
**Mercure Hotel Harbourside** - Carens - Australia  
**Omma** - Santorini - Greece  
**Royalton Hotel Riviera Cancun** - Mexico  
**Ocean Club** - Marbella - Spain  
**Grand Palladium Lady Hamilton** - Jamaïca  
**Radisson Blu** - Dakar - Senegal  
**Golf Club Saint-Tropez** - Saint Tropez - France  
**La mère germaine** - Châteauneuf-du-Pape - France  
**Villa Gemini** - Mykonos - Greece  
**The Ritz-Carlton** - Cyprus



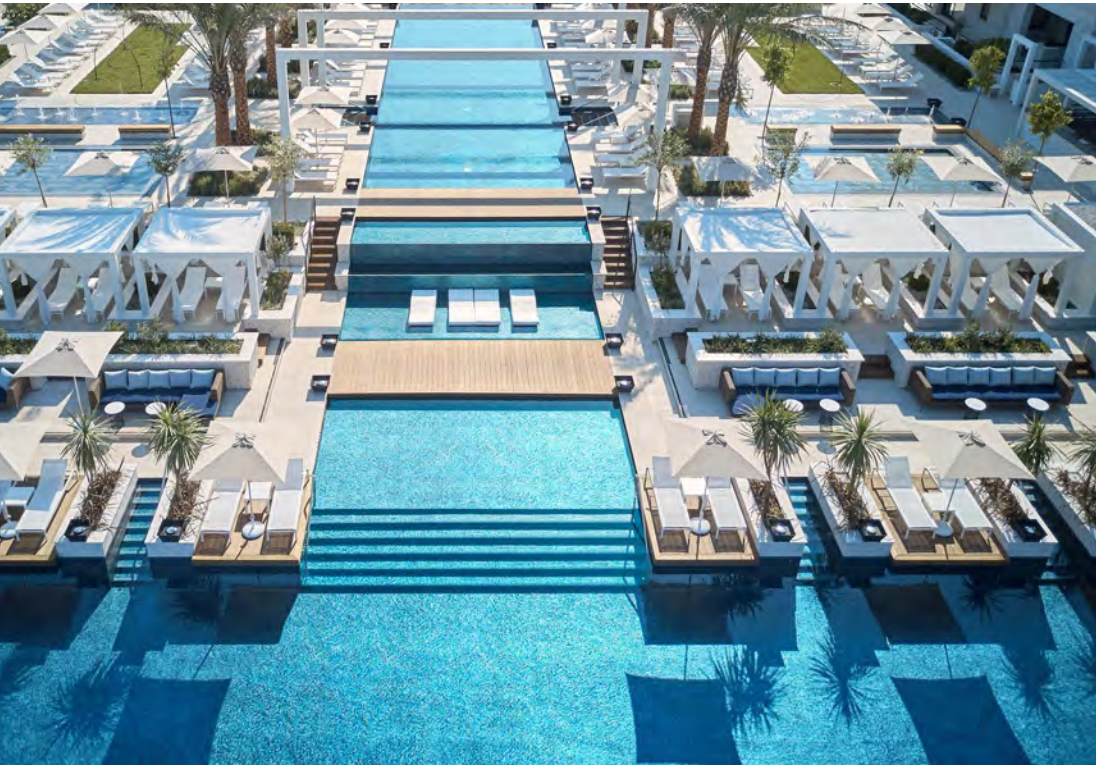





## TECHNICAL SPECIFICATIONS

The representation of colours, dimensions and weights may differ from reality as may variations when a product is handmade. Dimensions and technical details are subject to change without prior notice. Jardinico reserves the right to make any improvements such as technological and aesthetical modifications to its models, including adjustments of sizes and materials when it comes to technical developments or availability of raw materials.



# JCP.1 SERIES

Center pole frame, powder coated aluminium.  
Canopy 100% solution dyed acrylic.  
Tilt and rotation not applicable.

**base 44 kg:** max. 43 km/h, 26.7 mph  
**base 65 kg:** max. 58 km/h, 36 mph

## JCP.102 - 230 X 230 CM

### UFJCP.102 FRAME

	A01 white		A03 linen
	A10 cappuccino		A12 alu teak
	A31 charcoal		A32 black

### UCJCP.102 CANOPY

#### CATEGORY 3

	C003 pearl		C011 cotton
	C022 Nile <b>NEW</b>		C207 onyx
	C210 pitch		C305 umber

#### CATEGORY 2

	C019 tofu <b>NEW</b>		C023 heather <b>NEW</b>
---	----------------------	---	-------------------------

#### CATEGORY 3

see overview fabrics on p. 241 - minimum 8 umbrellas / colour

#### CATEGORY 2

see overview fabrics on p. 242

### UBJCP.15 BASE - PARASOLVOET 44 kg

	S01 white		S03 linen
	S31 charcoal		S32 black

**UBJCP.1565** base - parasolvoet 65 kg (same colours as base 44 kg)

**UBIGB-JCP.15** in ground base / **UBOGB-JCP.15** on ground base

### COVER

	UPJCP.15-X77 black
---	--------------------

17 kg, 37.5 lbs nett  
excl. base

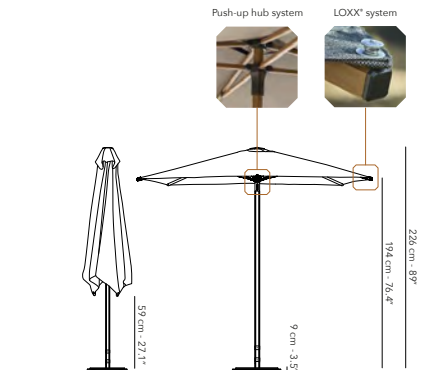

All dimensions exclude the base.  
\*Easy to open and close without touching furniture.

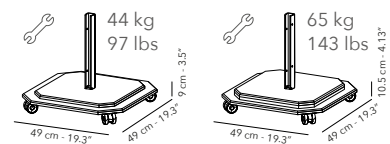
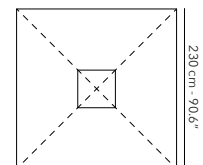
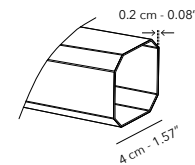

Hot galvanized steel plates, powder coated.  
Four mounted wheels that rotate 360°, each with a brake.  
Has the same colour as its frame.  
An alu teak or cappuccino frame has a charcoal base.

Center pole frame, powder coated aluminium.  
 Canopy 100% solution dyed acrylic.  
 Tilt and rotation not applicable.

# JCP.2 SERIES

max. 58 km/h, 36 mph

## JCP.201 - 400 X 400 CM





56 kg, 123.5 lbs nett  
 excl. base

### UFJCP.201 FRAME

	A01 white		A31 charcoal
---	-----------	---	--------------

### UCJCP.201 CANOPY

#### CATEGORY 3

	C003 pearl		C011 cotton
	C022 Nile <b>NEW</b>		C207 onyx
	C210 pitch		C305 umber

#### CATEGORY 2

	C019 tofu <b>NEW</b>		C023 heather <b>NEW</b>
---	----------------------	---	-------------------------

#### CATEGORY 3

see overview fabrics on p. 241 - minimum 8 umbrellas / colour

#### CATEGORY 2

see overview fabrics on p. 242

### UBJCP.2S-3S BASE

	S01 white		S31 charcoal
---	-----------	---	--------------

UBIGB-JCP.2S-3S in ground base / UBOGB-JCP.2S-3S on ground base

OPT. UAJCP.2S-3S in/on ground base plate cover (same colours as base)  
 OPTIONAL

### COVER

	UPJCP.2S-X77 black
---	--------------------

### GUTTERS

UAJCP.2S colour of the canopy

Telescopic hub system\*

LOXX® system

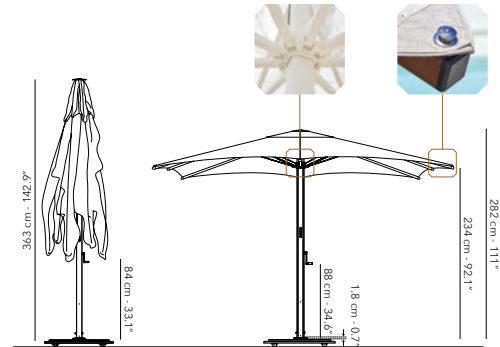

All dimensions exclude the base.  
 \*Easy to open and close without touching furniture.

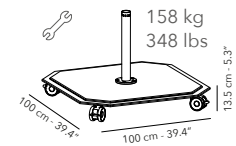
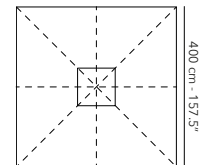
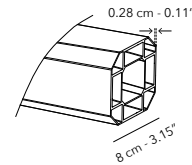

Hot galvanized steel plates, powder coated.  
 Four mounted wheels that rotate 360°, each with a brake.  
 Has the same colour as its frame.



# JCP.2 SERIES

Center pole frame, powder coated aluminium.  
Canopy 100% solution dyed acrylic.  
Tilt and rotation not applicable.

## JCP.202 - 500 X 500 CM





max. 58 km/h, 36 mph

### UFJCP.202 FRAME

	A01 white		A31 charcoal
---	-----------	---	--------------

### UCJCP.202 CANOPY

#### CATEGORY 3

	C003 pearl		C011 cotton
	C022 Nile <b>NEW</b>		C207 onyx
	C210 pitch		C305 umber

#### CATEGORY 2

	C019 tofu <b>NEW</b>		C023 heather <b>NEW</b>
---	----------------------	---	-------------------------

#### CATEGORY 3

see overview fabrics on p. 241 - minimum 2 umbrellas / colour

#### CATEGORY 2

see overview fabrics on p. 242

### UBJCP.2S-3S BASE

	S01 white		S31 charcoal
---	-----------	---	--------------

UBIGB-JCP.2S-3S in ground base / UBOGB-JCP.2S-3S on ground base

OPT.  
OPTIONAL

UAJCP.2S-3S in/on ground base plate cover (same colours as base)

### COVER

	UPJCP.2S-X77 black
---	--------------------

### GUTTERS

UAJCP.2S colour of the canopy

56 kg, 123.5 lbs nett  
excl. base

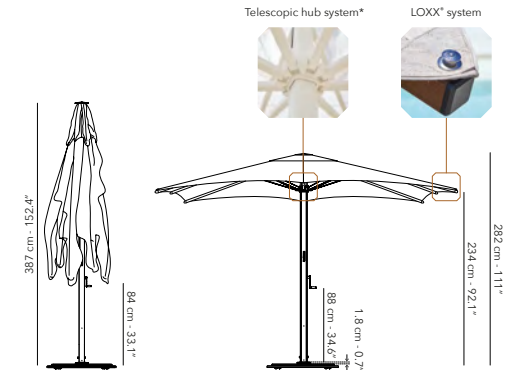

All dimensions exclude the base.  
\* Easy to open and close without touching furniture.

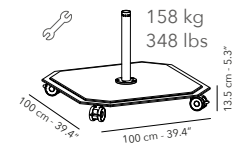
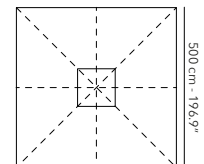
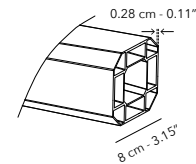

Hot galvanized steel plates, powder coated.  
Four mounted wheels that rotate 360°, each with a brake.  
Has the same colour as its frame.

Center pole frame, powder coated aluminium.  
 Canopy 100% solution dyed acrylic.  
 Tilt and rotation not applicable.

# JCP.2 SERIES

max. 58 km/h, 36 mph

## JCP.203 - Ø 450 CM







42 kg, 92.6 lbs nett  
 excl. base

### UFJCP.203 FRAME

	A01 white		A31 charcoal
---	-----------	---	--------------

### UCJCP.203 CANOPY

#### CATEGORY 3

	C003 pearl		C011 cotton
	C022 Nile <b>NEW</b>		C207 onyx
	C210 pitch		C305 umber

#### CATEGORY 2

	C019 tofu <b>NEW</b>		C023 heather <b>NEW</b>
---	----------------------	---	-------------------------

#### CATEGORY 3

see overview fabrics on p. 241 - minimum 3 umbrellas / colour

#### CATEGORY 2

see overview fabrics on p. 242

### UBJCP.2S-3S BASE

	S01 white		S02 silver
	S31 charcoal		

UBIGB-JCP.2S-3S in ground base / UBOGB-JCP.2S-3S on ground base

OPT. UAJCP.2S-3S in/on ground base plate cover (same colours as base)  
 OPTIONAL

### COVER

	UPJCP.2S-X77 black
---	--------------------

### GUTTERS

UAJCP.2S colour of the canopy



Telescopic hub system\*      LOXX® system

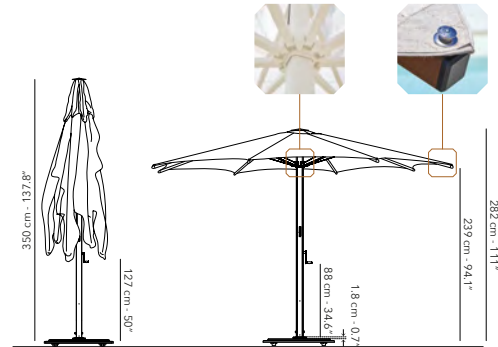

All dimensions exclude the base.  
 \* Easy to open and close without touching furniture.

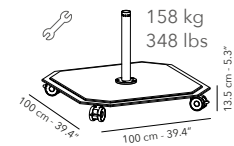
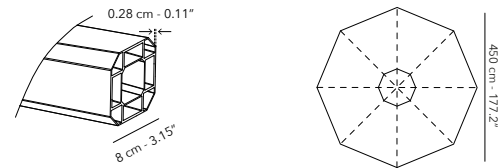

Hot galvanized steel plates, powder coated.  
 Four mounted wheels that rotate 360°, each with a brake.  
 Has the same colour as its frame.



# JCP.3 SERIES

UPDATED - ALSO AVAILABLE WITH LED

Free pole frame, powder coated aluminium.  
Canopy 100% solution dyed acrylic.  
Tilt in height, left and right, rotation 360°.

## JCP.301 - 300 X 300 CM



max. 58 km/h, 36 mph

### UFJCP.301 FRAME

	A01 white		A03 linen
	A10 cappuccino		A12 alu teak
	A31 charcoal		A32 black

\* LED frame only available in  
A03 linen & A31 charcoal

### UCJCP.301 CANOPY

#### CATEGORY 3

	C003 pearl		C011 cotton
	C022 Nile <b>NEW</b>		C207 onyx
	C210 pitch		C305 umber

#### CATEGORY 2

	C019 tofu <b>NEW</b>		C023 heather <b>NEW</b>
--	----------------------	--	-------------------------

#### CATEGORY 3

see overview fabrics on p. 241 - minimum 3 umbrellas / colour

#### CATEGORY 2

see overview fabrics on p. 242

### UBJCP.2S-3S BASE

	S01 white		S03 linen
	S31 charcoal		S32 black

UBIGB-JCP.2S-3S in ground base / UBOGB-JCP.2S-3S on ground base

OPT. UAJCP.2S-3S in/on ground base plate cover (same colours as base)  
OPTIONAL

### COVER

	UPJCP.3S-X77 black
--	--------------------

42 kg, 92.6 lbs nett  
excl. base

Slider & crank handle

LOXX® system

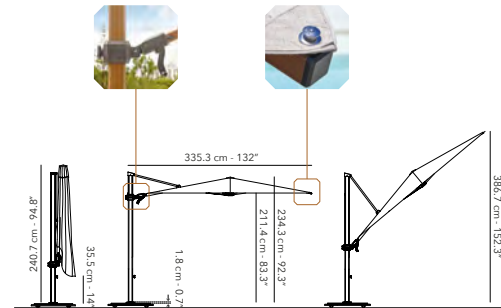

All dimensions exclude the base.

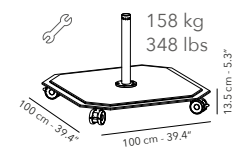
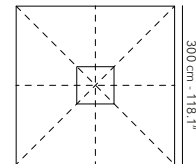
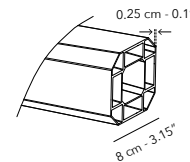

Hot galvanized steel plates, powder coated.  
Four mounted wheels that rotate 360°, each with a brake.  
Has the same colour as its frame.  
An alu teak or cappuccino frame has a charcoal base.

Free pole frame, powder coated aluminium.  
 Canopy 100% solution dyed acrylic.  
 Tilt in height, left and right, rotation 360°.

# JCP.3 SERIES



max. 58 km/h, 36 mph

## JCP.302 - 260 X 260 CM

### UFJCP.302 FRAME

	A01 white		A10 cappuccino
	A12 alu teak		A31 charcoal

### UCJCP.302 CANOPY

#### CATEGORY 3

	C003 pearl		C011 cotton
	C022 Nile <b>NEW</b>		C207 onyx
	C210 pitch		C305 umber

#### CATEGORY 2

	C019 tofu <b>NEW</b>		C023 heather <b>NEW</b>
--	----------------------	--	-------------------------

#### CATEGORY 3

see overview fabrics on p. 241 - minimum 3 umbrellas / colour

#### CATEGORY 2

see overview fabrics on p. 242

### UBJCP.2S-3S BASE

	S01 white		S31 charcoal
--	-----------	--	--------------

UBIGB-JCP.2S-3S in ground baser / UBOGB-JCP.2S-3S on ground base

OPT. UAJCP.2S-3S in/on ground base plate cover (same colours as base)  
 OPTIONAL

### COVER

	UPJCP.3S-X77 black
--	--------------------

31 kg, 68.3 lbs nett  
 excl. base

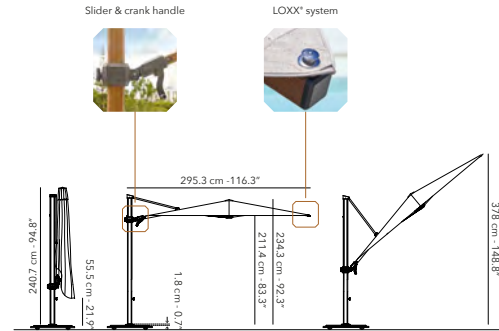

All dimensions exclude the base.

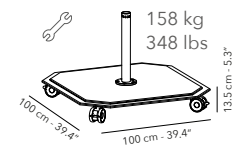
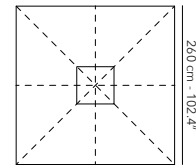
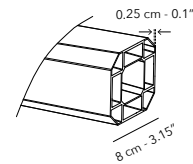

Hot galvanized steel plates, powder coated.  
 Four mounted wheels that rotate 360°, each with a brake.  
 Has the same colour as its frame.  
 An alu teak or cappuccino frame has a charcoal base.



# JCP.3 SERIES

Free pole frame, powder coated aluminium.  
Canopy 100% solution dyed acrylic.  
Tilt in height, left and right, rotation 360°.

## JCP.303 - Ø 350 CM



max. 58 km/h, 36 mph

### UFJCP.303 FRAME

	A01 white		A03 linen
	A10 cappuccino		A12 alu teak
	A31 charcoal		

### UCJCP.303 CANOPY

#### CATEGORY 3

	C003 pearl		C011 cotton
	C022 Nile <b>NEW</b>		C207 onyx
	C210 pitch		C305 umber

#### CATEGORY 2

	C019 tofu <b>NEW</b>		C023 heather <b>NEW</b>
--	----------------------	--	-------------------------

#### CATEGORY 3

see overview fabrics on p. 241 - minimum 3 umbrellas / colour

#### CATEGORY 2

see overview fabrics on p. 242

### UBJCP.2S-3S BASE

	S01 white		S03 linen
	S31 charcoal		

UBIGB-JCP.2S-3S in ground base / UBOGB-JCP.2S-3S on ground base

OPT. UAJCP.2S-3S in/on ground base plate cover (same colours as base)  
OPTIONAL

### COVER

	UPJCP.3S-X77 black
--	--------------------

34 kg, 75 lbs nett  
excl. base

Slider & crank handle

LOXX® system

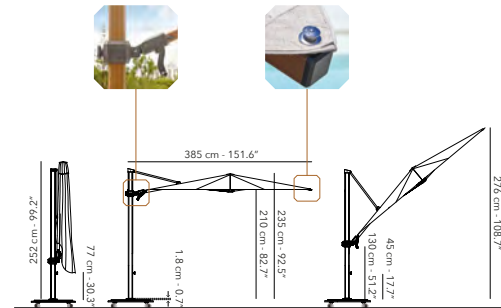

All dimensions exclude the base.

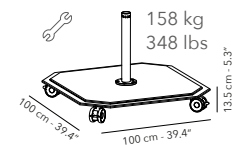
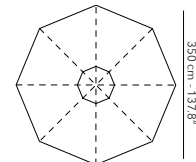
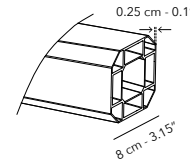

Hot galvanized steel plates, powder coated.  
Four mounted wheels that rotate 360°, each with a brake.  
Has the same colour as its frame.  
An alu teak or cappuccino frame has a charcoal base.

Free pole frame, powder coated aluminium.  
 Canopy 100% solution dyed acrylic.  
 Tilt in height, left and right, rotation 360°.

# JCP.4 SERIES

## JCP.401 - 370 X 370 CM



360°

max. 58 km/h, 36 mph

### UFJCP.401 FRAME

	A01 white		A03 linen
	A10 cappuccino		A12 alu teak
	A31 charcoal		A32 black

### UCJCP.401 CANOPY

#### CATEGORY 3

	C003 pearl		C011 cotton
	C022 Nile <b>NEW</b>		C207 onyx
	C210 pitch		C305 umber

#### CATEGORY 2

	C019 tofu <b>NEW</b>		C023 heather <b>NEW</b>
--	----------------------	--	-------------------------

#### CATEGORY 3

see overview fabrics on p. 241 - minimum 3 umbrellas / colour

#### CATEGORY 2

see overview fabrics on p. 242

### UBJCP.4S BASE

	S01 white		S03 linen
	S31 charcoal		S32 black

**UBIGB-JCP.4S-5S-6S** in ground base / **UBOGB-JCP.2S-3S** on ground base

**OPT. UBOGB-JCP.4S-5S-6S** in/on ground base plate cover (same colours as base) **OPTIONAL**

### COVER

	UPJCP.4S-X77 black
--	--------------------

64 kg, 141.1 lbs nett  
 excl. base

Slider & crank handle

LOXX® system

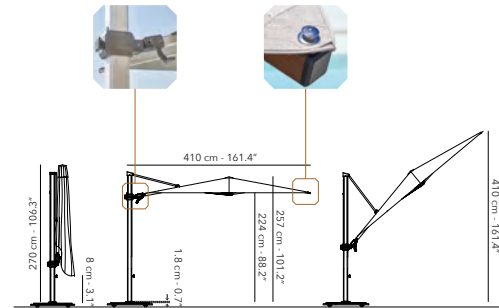

All dimensions exclude the base.

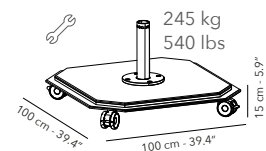
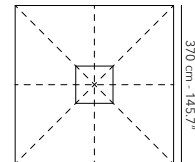
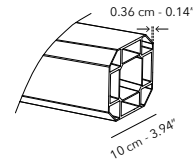

Hot galvanized steel plates, powder coated.  
 Four mounted wheels that rotate 360°, each with a brake.  
 Has the same colour as its frame.  
 An alu teak or cappuccino frame has a charcoal base.



# JCP.4 SERIES

Free pole frame, powder coated aluminium.  
Canopy 100% solution dyed acrylic.  
Tilt in height, left and right, rotation 360°.

## JCP.402 - 425 X 300 CM



max. 58 km/h, 36 mph

### UFJCP.402 FRAME

	A01 white		A03 linon
	A10 cappuccino		A12 alu teak
	A31 charcoal		

### UCJCP.402 CANOPY

#### CATEGORY 3

	C003 pearl		C011 cotton
	C022 Nile <b>NEW</b>		C207 onyx
	C210 pitch		C305 umber

#### CATEGORY 2

	C019 tofu <b>NEW</b>		C023 heather <b>NEW</b>
--	----------------------	--	-------------------------

#### CATEGORY 3

see overview fabrics on p. 241 - minimum 3 umbrellas / colour

#### CATEGORY 2

see overview fabrics on p. 242

### UBJCP.4S BASE

	S01 white		S03 linon
	S31 charcoal		

UBIGB-JCP.4S-5S-6S in ground base / UBOGB-JCP.2S-3S on ground base

OPT. UBOGB-JCP.4S-5S-6S in/on ground base plate cover (same colours as base) **OPTIONAL**

### COVER

	UPJCP.4S-X77 black
--	--------------------

53 kg, 116.8 lbs nett  
excl. base

Slider & crank handle

LOXX® system

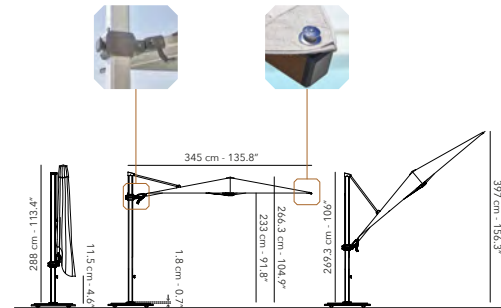

All dimensions exclude the base.

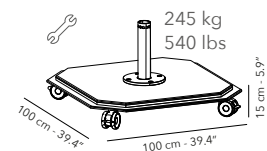
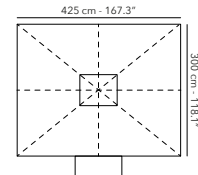
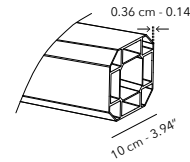

Hot galvanized steel plates, powder coated.  
Four mounted wheels that rotate 360°, each with a brake.  
Has the same colour as its frame.  
An alu teak or cappuccino frame has a charcoal base.

Free pole frame, powder coated aluminium.  
 Canopy 100% solution dyed acrylic.  
 Tilt in height, left and right, rotation 360°.

# JCP.4 SERIES

## JCP.403 - Ø 400 CM



360°

max. 58 km/h, 36 mph

### UFJCP.403 FRAME

	A01 white		A10 cappuccino
	A12 alu teak		A31 charcoal

53 kg, 116.8 lbs nett  
 excl. base

### UCJCP.403 CANOPY

#### CATEGORY 3

	C003 pearl		C011 cotton
	C022 Nile <b>NEW</b>		C207 onyx
	C210 pitch		C305 umber

#### CATEGORY 2

	C019 tofu <b>NEW</b>		C023 heather <b>NEW</b>
--	----------------------	--	-------------------------

#### CATEGORY 3

see overview fabrics on p. 241 - minimum 3 umbrellas / colour

#### CATEGORY 2

see overview fabrics on p. 242

### UBJCP.4S BASE

	S01 white		S31 charcoal
--	-----------	--	--------------

UBIGB-JCP.4S-5S-6S in ground base / UBOGB-JCP.2S-3S on ground base

OPT. UBOGB-JCP.4S-5S-6S in/on ground base plate cover (same colours as base) **OPTIONAL**

### COVER

	UPJCP.4S-X77 black
--	--------------------

Slider & crank handle

LOXX® system

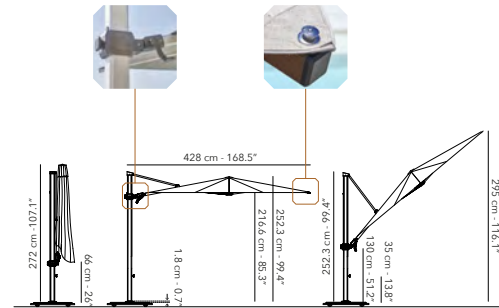

All dimensions exclude the base.

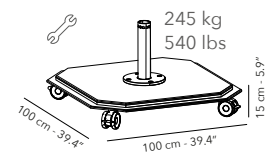
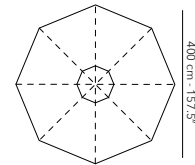
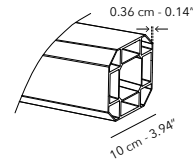

Hot galvanized steel plates, powder coated.  
 Four mounted wheels that rotate 360°, each with a brake.  
 Has the same colour as its frame.  
 An alu teak or cappuccino frame has a charcoal base.



# JCP.4 SERIES

Free pole frame, powder coated aluminium.  
 Canopy 100% solution dyed acrylic.  
 Tilt in height, left and right, rotation 360°.

## JCP.404 - 250 X 350 CM



max. 58 km/h, 36 mph

60 kg, 132.3 lbs nett  
 excl. base

### UFJCP.404 FRAME

	A01 white		A03 linen
	A10 cappuccino		A12 alu teal
	A31 charcoal		

### UCJCP.404 CANOPY

#### CATEGORY 3

	C003 pearl		C011 cotton
	C022 Nile <b>NEW</b>		C207 onyx
	C210 pitch		C305 umber

#### CATEGORY 2

	C019 tofu <b>NEW</b>		C023 heather <b>NEW</b>
--	----------------------	--	-------------------------

#### CATEGORY 3

see overview fabrics on p. 241 - minimum 3 umbrellas / colour

#### CATEGORY 2

see overview fabrics on p. 242

### UBJCP.4S BASE

	S01 white		S03 linen
	S31 charcoal		

UBIGB-JCP.4S-5S-6S in ground base / UBOGB-JCP.2S-3S on ground base

OPT. UBOGB-JCP.4S-5S-6S in/on ground base plate cover (same colours as base) **OPTIONAL**

### COVER

	UPJCP.4S-X77 black
--	--------------------

MIX & MATCH

FAST STOCK

ON DEMAND

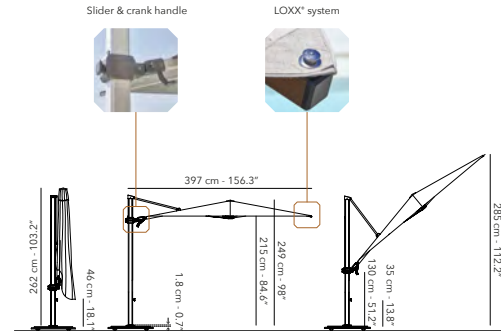

All dimensions exclude the base.

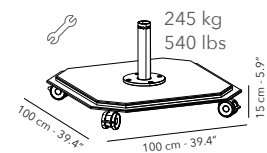
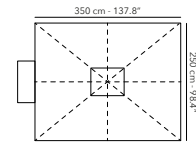
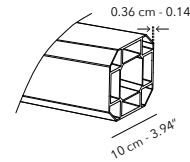

Hot galvanized steel plates, powder coated.  
 Four mounted wheels that rotate 360°, each with a brake.  
 Has the same colour as its frame.  
 An alu teal or cappuccino frame has a charcoal base.





# JCP.5 SERIES

Free pole frame, powder coated aluminium.  
Canopy 100% solution dyed acrylic.  
Tilt in height, left and right, rotation 360°.

## JCP.501 - 4\* 300 X 300 CM



max. 58 km/h, 36 mph

### UFJCP.501 FRAME

	A12 alu teak		A31 charcoal
--	--------------	--	--------------

143.5 kg, 316.4 lbs nett  
excl. base

### UCJCP.501 CANOPY

#### CATEGORY 3

	C003 pearl		C011 cotton
	C022 Nile <b>NEW</b>		C207 onyx
	C210 pitch		C305 umber

#### CATEGORY 2

	C019 tofu <b>NEW</b>		C023 heather <b>NEW</b>
--	----------------------	--	-------------------------

#### CATEGORY 3

see overview fabrics on p. 241 - minimum 3 umbrellas / colour

#### CATEGORY 2

see overview fabrics on p. 242

### UBJCP.5S-6S BASE

	S01 white		S31 charcoal
--	-----------	--	--------------

UBIGB-JCP.4S-5S-6S in ground base / UBOGB-JCP.2S-3S on ground base

OPT. UBOGB-JCP.4S-5S-6S in/on ground base plate cover  
(same colours as base) **OPTIONAL**

### COVER

	UPJCP.4S-X77 black
--	--------------------

### UAJCP.5S GUTTERS - GOUTTIÈRES - GOTEN (4x)

A fabric from our fast stock - Un tissu du fast stock - Een stof uit fast stock

Other fabric of your choice - Autre tissu de votre choix - Stof naar keuze

Slider & crank handle      LOXX® system

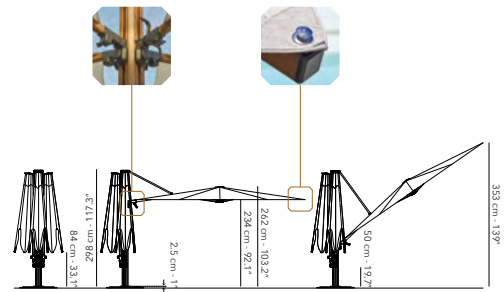

All dimensions exclude the base.

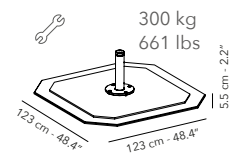
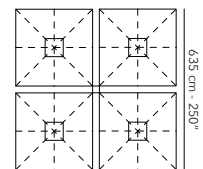
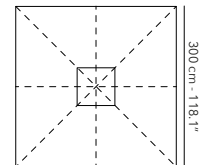
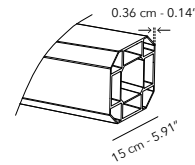

Hot galvanized steel plates, powder coated.  
Base without wheels.  
Has the same colour as its frame.  
An alu teak frame has a charcoal base.

Free pole frame, powder coated aluminium.  
 Canopy 100% solution dyed acrylic.  
 Tilt in height, left and right, rotation 360°.

# JCP.6 SERIES



max. 58 km/h, 36 mph

## JCP.601 - 2\* 300 X 300 CM

### UFJCP.601 FRAME

	A10 cappuccino		A12 alu teak
	A31 charcoal		

86.5 kg, 190.7 lbs nett  
 excl. base

### UCJCP.601 CANOPY

#### CATEGORY 3

	C003 pearl		C011 cotton
	C022 Nile <b>NEW</b>		C207 onyx
	C210 pitch		C305 umber

#### CATEGORY 2

	C019 tofu <b>NEW</b>		C023 heather <b>NEW</b>
--	----------------------	--	-------------------------

#### CATEGORY 3

see overview fabrics on p. 241 - minimum 3 umbrellas / colour

#### CATEGORY 2

see overview fabrics on p. 242

### UBJCP.5S-6S BASE

	S31 charcoal	
--	--------------	--

UBIGB-JCP.4S-5S-6S in ground base / UBOGB-JCP.2S-3S on ground base

OPT. UBOGB-JCP.4S-5S-6S in/on ground base plate cover  
 (same colours as base) **OPTIONAL**

### COVER

	UPJCP.4S-X77 black
--	--------------------

Slider & crank handle



LOXX® system

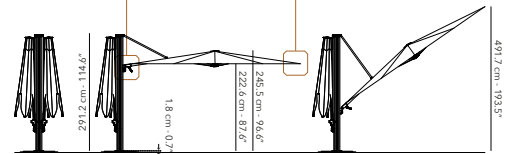

All dimensions exclude the base.

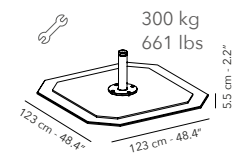
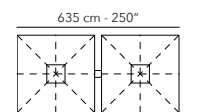
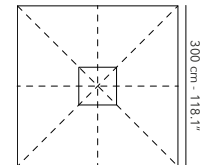
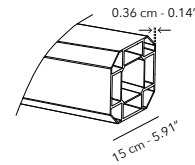

Hot galvanized steel plates, powder coated.  
 Base without wheels.  
 Has the same colour as its frame.  
 An alu teak or cappuccino frame has a charcoal base.



# AZORE

UPDATED with new combination

Free pole frame, powder coated aluminium.  
Canopy is weatherproof and colour resistant.  
Tilt in height, left and right, rotation 360°.

**AZORE** fully assembled (excl. base)



max. 27 km/h, 17 mph

## UMAZO FRAME & CANOPY

		A01C101 white & cloud
		A08C301 matt oak & taupe <b>NEW</b>
		A30C204 anthracite & night
		A32C208 black & black

## UB BASE

	AZO-125-NW-G04 azore
OPTIONAL	AZO-EW60-G04 silk grey granite tiles - tuiles - tegels

OPTIONAL

	UABTEN-SP037-SET set of 4 stainless steel wheels
	UABANT-SP037(A)-SET set of 4 synthetic wheels

IGB-AZO-4G-MEDIUM in ground base

OGB-AZO-4G-MEDIUM on ground base

## UP COVER

AZO-M-X75 grey
----------------

## UA ACCESSORIES

LUN-LED02 Luna LED light
--------------------------

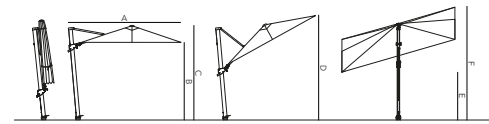
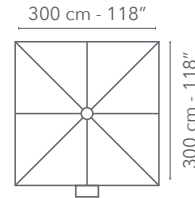

300 X 300 CM

	27 kg - 59.5 lbs nett excl. base
A	375 cm - 147.6"
B	203 cm - 79.9"
C	262 cm - 103.1"
D	355 cm - 139.8"
E	130 cm - 51.2"
F	300 cm - 118.1"



300 x 300 cm











# ANTEGO

## ANTEGO

### UFANT FRAME - STRUCTURE

	A01 white		A03 linen
	A12 alu teak		A14 lava
	A30 anthracite		A32 black

### UCANT CANOPY

#### CATEGORY 1

	C001 natural		C010 latte
	C024 clay		C101 cloud
	C208 black <b>NEW</b>		C211 steel
	C304 walnut		

#### CATEGORY 2

	C019 tofu <b>NEW</b>		C023 heather <b>NEW</b>
---	----------------------	---	-------------------------

#### CATEGORY 3

	C003 pearl		C011 cotton
	C022 nile		C207 onyx
	C210 pitch		C305 umber

#### CATEGORY 3

**ON DEMAND** see overview fabrics on p. 241 - minimum 6 umbrellas / colour

#### CATEGORY 2

**ON DEMAND** see overview fabrics on p. 242

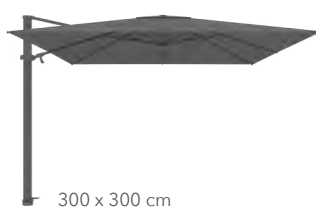
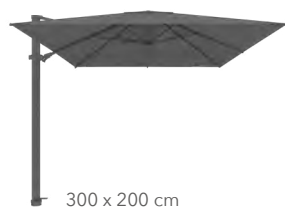
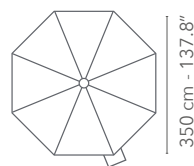
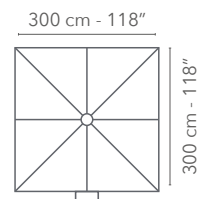
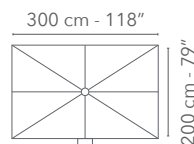

Free pole frame, powder coated aluminium.  
Canopy is weatherproof and colour resistant.  
Tilt in height, left and right, rotation 360°.



max. 39 km/h, 24 mph

**UB BASE - PARASOLVOET**

**BASES WITH OPTIONAL WHEELS**

	<b>ANT-120-NW-G04</b> silk grey granite
OPTIONAL	<b>ANT-EW60-G04</b> silk grey granite tiles - tuiles - tegels (p.44)
	<b>ANT-120-NW-G32</b> black granite
	<b>ANT-125-NW-G13</b> Egyptian sandstone
	<b>ANT-125-NW-B01</b> concrete white
	<b>ANT-125-NW-B03</b> concrete linen
	<b>ANT-125-NW-B30</b> concrete anthracite
	<b>UABTEN-SP037-SET</b> set of 4 stainless steel wheels
	<b>UABANT-SP037(A)-SET</b> set of 4 synthetic wheels

**BASES WITH WHEELS INCLUDED**

	<b>ANT-125-S01</b> powder coated steel white <b>NEW</b>
	<b>ANT-125-S03</b> powder coated steel linen <b>NEW</b>
	<b>ANT-125-S30</b> powder coated steel anthracite <b>NEW</b>
	<b>ANT-125-S32</b> powder coated steel black <b>NEW</b>

**IGB / OGB**

<b>IGB-FP-5G-MEDIUM</b> in ground base - ancre de sol - grondanker
<b>OGB-FP-5G-MEDIUM</b> on ground base - plaque de fixation - bevestigingsplaat

**UP COVER - HOUSSE - HOES**

<b>ANT-M-X75</b> grey
<b>ANT-M-X74</b> gris nature

**UA ACCESSORIES - ACCESSOIRES**

<b>LUN-LED02</b> Luna LED light - lumière - verlichting
---

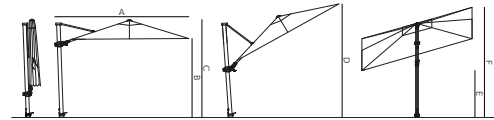

	300 X 200 CM	300 X 300 CM	Ø 350 CM
	33 kg - 72.8 lbs nett excl. base	34 kg - 75 lbs nett excl. base	35 kg - 77.1 lbs nett excl. base
A	275 cm - 108.3"	375 cm - 147.6"	427 cm - 168.1"
B	203 cm - 79.9"	203 cm - 79.9"	188 cm - 74"
C	262 cm - 103.1"	262 cm - 103.1"	261 cm - 102.8"
D	280 cm - 110"	355 cm - 139.8"	441 cm - 173.6"
E	130 cm - 51.2"	130 cm - 51.2"	130 cm - 51.2"
F	300 cm - 118.1"	300 cm - 118.1"	375 cm - 92.5"





# LIMA

## UPDATED

### LIMA

#### UFLIM FRAME

	A01 white		A03 linen
	A30 anthracite		A32 black

#### UCANT CANOPY

##### CATEGORY 1

	C001 natural		C010 latte
	C024 clay <b>NEW</b>		C101 cloud
	C208 black		C211 steel
	C304 walnut		

##### CATEGORY 2

	C019 tofu <b>NEW</b>		C023 heather <b>NEW</b>
---	----------------------	---	-------------------------

##### CATEGORY 3

	C003 pearl		C011 cotton
	C022 nile		C207 onyx
	C210 pitch		C305 umber

##### CATEGORY 3

see overview fabrics on p. 241 - minimum 6 umbrellas / colour

##### CATEGORY 2

see overview fabrics on p. 242

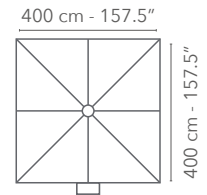
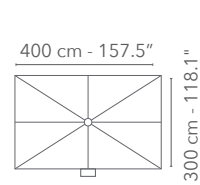

Free pole frame, powder coated aluminium.  
Canopy is weatherproof and colour resistant.  
Tilt in height, rotation 360°.







max. 45 km/h, 28 mph

**UB BASE - PARASOLVOET**

**BASES WITH WHEELS INCLUDED**

	<b>LIM-silk grey granite</b>	<b>UPDATED</b>
---	------------------------------	----------------

**BASES WITHOUT WHEELS**

	<b>LIM-HAL-A01</b> half base white	<b>NEW</b>
	<b>LIM-HAL-A03</b> half base linen	<b>NEW</b>
	<b>LIM-HAL-A30</b> half base anthracite	<b>NEW</b>
	<b>LIM-HAL-A32</b> half base black	<b>NEW</b>

**IGB / OGB**

<b>IGB-FP-LARGE</b> in ground base - ancre de sol - grondanker
<b>OGB-FP-LARGE</b> on ground base - plaque de fixation - bevestigingsplaat

**UP COVER - HOUSSE - HOES**

<b>LIM-L-X75</b> grey
-----------------------

**UA ACCESSORIES - ACCESSOIRES**

<b>LUN-LED02</b> Luna LED light - lumière - verlichting
---

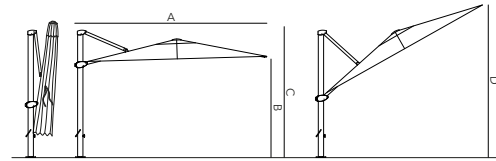

	400 X 300 CM	400 X 400 CM
	46 kg - 101.4 lbs nett excl. base	54 kg - 119 lbs nett excl. base
A	364 cm - 106.7"	464 cm - 182.7"
B	240 cm - 94.5"	240 cm - 94.5"
C	290 cm - 114.2"	290 cm - 114.2"
D	384 cm - 151.2"	364 cm - 143.3"



# TULI

## UPDATED

### TULI

#### UMTUL FRAME & CANOPY

##### CATEGORY 1

CLASSICS			A01C101 white & cloud
			A03C010 linen & latte
			A12C001 alu teal & natural
			A32C208 black & black

SPECIALS			A01C001Y04 white & natural with sisal piping <b>NEW</b>
			A01C447Y01 white & kale with bone piping <b>NEW</b>
			A01C448Y01 white & spa with bone piping <b>NEW</b>
			A01C449Y01 white & admiral with bone piping <b>NEW</b>

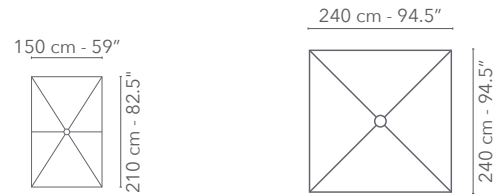







Mid pole frame, powder coated aluminium with locking pins.  
Flexible rib ends in fiber glass.  
Diameter of the pole: 38 mm, 1.5"

max. 65 km/h, 40.4 mph







UB BASE - PARASOLVOET

BASES WITH WHEELS INCLUDED

	<b>TUL-50-B01</b> tuli round white
	<b>TUL-50-B03</b> tuli round linen <b>NEW</b>
	<b>TUL-50-B32</b> tuli round black

	<b>ELB-44-S01</b> elba medium white hot dip galvanized
	<b>ELB-44-S03</b> elba medium linen hot dip galvanized
	<b>ELB-44-S31</b> elba medium charcoal hot dip galvanized

BASES WITH OPTIONAL WHEELS

	<b>LUC-60-NT-B01</b> lucca heavy (no tube) white
	<b>LUC-60-NT-B06</b> lucca heavy (no tube) hazel
	<b>LUC-60-NT-B30</b> lucca heavy (no tube) anthracite
	<b>UABLUC-25/55-A01SP036</b> lucca base tube 25-55mm white
	<b>UABLUC-25/55-A06SP036</b> lucca base tube 25-55mm hazel
	<b>UABLUC-25/55-A30SP036</b> lucca base tube 25-55mm anthracite
OPTIONAL	<b>UALUC-WHE.60</b> lucca heavy wheels - roues - wielen

IGB / OGB

<b>IGB-MP-SM</b> in ground base - ancre de sol - grondanker*
<b>BS-MP-SMALL</b> beach spike

\*Locking only possible under slider. - Verouillage uniquement sous le glisseur. - Vergrendeling enkel mogelijk onder de slider



UP COVER - HOUSSE - HOES

<b>UMB-S-X75</b> grey
-----------------------

UA ACCESSORIES - ACCESSOIRES

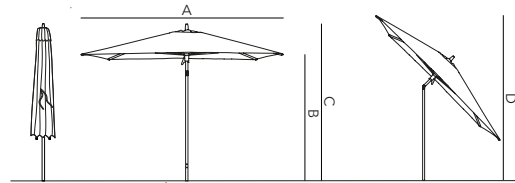
<b>LUN-LED02</b> Luna LED light - lumière - verlichting
---



	150 X 210 CM	200 X 200 CM
	5 kg - lbs nett excl. base - voet 6.2 kg - lbs gross excl. base - voet	5 kg - lbs nett excl. base - voet 7 kg - lbs gross excl. base - voet
	237 x 14 x 14 cm, cbm excl. base - voet	237 x 14 x 14 cm, cbm excl. base - voet
A	150 cm - 59"	200 cm - 78.7"
B	205 cm - 80.7"	195 cm - 76.8"
C	230 cm - 90.6"	230 cm - 90.6"
D	245 cm - 96.5"	249 cm - 98"





	240 X 240 CM	ø 270 CM
	5.4 kg - lbs nett excl. base - voet 7.2 kg - lbs gross excl. base - voet	5.7 kg - lbs nett excl. base - voet 7 kg - lbs gross excl. base - voet
	237 x 14 x 14 cm, 0.04 cbm excl. base - voet	237 x 17 x 17 cm, 0.cbm excl. base - voet
A	240 cm - 94.5"	270 cm - 106.3"
B	196 cm - 77.2"	199 cm - 78.3"
C	230 cm - 90.6"	230 cm - 90.6"
D	259 cm - 102"	270 cm - 106.3"



# AMALFI







## AMALFI

### UFAMA FRAME - STRUCTURE

	A01 white		A03 linen
	A12 alu teak		A30 anthracite
	A32 black		

### UCAMA CANOPY - TOILE - DOEK



#### CATEGORY 1

	C001 natural		C010 latte
	C024 clay <b>NEW</b>		C101 cloud
	C208 black		C211 steel
	C304 walnut		

#### CATEGORY 2

	C019 tofu <b>NEW</b>		C023 heather <b>NEW</b>
---	----------------------	---	-------------------------

#### CATEGORY 3

	C003 pearl		C011 cotton
	C022 nile		C207 onyx
	C210 pitch		C305 umber

#### CATEGORY 3

see overview fabrics on p. 241 - minimum 6 umbrellas / colour

#### CATEGORY 2



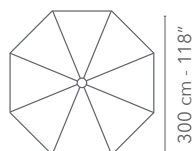
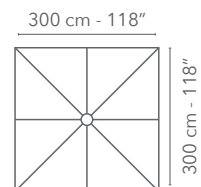
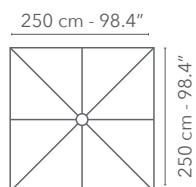





see overview fabrics on p. 242



Mid pole frame, powder coated aluminium.  
 Canopy is weatherproof and colour resistant.  
 Diameter of the pole: ø 40 mm, 1.6".

**UB BASE - PARASOLVOET**

**BASES WITH WHEELS INCLUDED**

	<b>ELB-44-S01</b> elba medium white hot dip galvanized
	<b>ELB-44-S03</b> elba medium linen hot dip galvanized
	<b>ELB-44-S31</b> elba medium charcoal hot dip galvanized
	<b>LUC-60-NT-B01</b> lucca heavy (no tube) white
	<b>LUC-60-NT-B06</b> lucca heavy (no tube) hazel
	<b>LUC-60-NT-B30</b> lucca heavy (no tube) anthracite
	<b>UABLUC-25/55-A01SP036</b> lucca base tube 25-55mm white
	<b>UABLUC-25/55-A06SP036</b> lucca base tube 25-55mm hazel
	<b>UABLUC-25/55-A30SP036</b> lucca base tube 25-55mm anthracite
OPTIONAL	<b>UALUC-WHE.60</b> lucca heavy wheels - roues - wielen

**IGB**

<b>IGB-MP-SM</b> in ground base - ancre de sol - grondanker
---

**UP COVER - HOUSSE - HOES**

<b>AMA-M-X75</b>
------------------

**UA ACCESSORIES - ACCESSOIRES**

<b>LUN-LED02</b> Luna LED light - lumière - verlichting
---

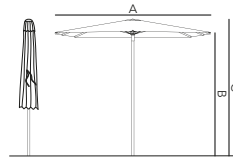

	250 X 250 CM	300 X 300 CM	Ø 300 CM
	15 kg - 33.1 lbs nett excl. base	16 kg - 35.2 lbs nett excl. base	16 kg - 35.2 lbs nett excl. base
A	250 cm - 98.4"	300 cm - 118.1"	300 cm - 118.1"
B	216 cm - 85"	216 cm - 85"	216 cm - 85"
C	250 cm - 98.4"	250 cm - 98.4"	250 cm - 98.4"



# MACRAMÉ

Diameter of the pole:  $\varnothing$  48 mm, 1.9".  
Mid pole frame, teak AB grade.  
Handknotted canopy, 100% cotton.

## MACRAMÉ fully assembled (excl. base)









max. 17 km/h, 10.6 mph

### UMMAC FRAME & CANOPY - STRUCTURE & TOILE - FRAME & DOEK



		<b>W62MR03</b> teak & macramé natural
		<b>W62MR13</b> teak & macramé sand

### UB BASE - VOET

#### BASES WITH OPTIONAL WHEELS

	<b>LUC-60-NT-B01</b> lucca heavy white
	<b>LUC-60-NT-B06</b> lucca heavy hazel
	<b>LUC-60-NT-B30</b> lucca heavy anthracite
	<b>UABLUC61-A01SP036</b> lucca base tube 61mm white
	<b>UABLUC61-A06SP036</b> lucca base tube 61mm hazel
	<b>UABLUC61-A30SP036</b> lucca base tube 61mm anthracite
OPTIONAL	<b>UALUC-WHE.60</b> lucca light wheels - roues - wielen

#### BASES WITH WHEELS

	<b>ELB-84-S01</b> elba heavy white hot dip galvanized
	<b>ELB-84-S03</b> elba heavy linen hot dip galvanized
	<b>ELB-84-S31</b> elba heavy charcoal hot dip galvanized

### IGB

<b>IGB-MP-SMALL</b> in ground base - grondanker - ancre de sol
--

### UP COVER - HOUSSE - HOES

<b>UMB-S-X75</b> grey
-----------------------

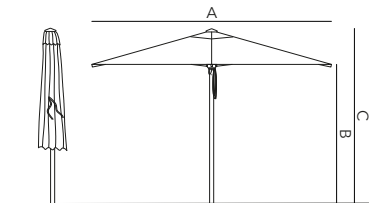
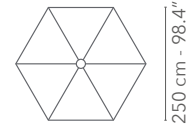

$\varnothing$  250 CM

	23 kg - 50.7 lbs nett excl. base - voet
	24 kg - 52.9 lbs gross excl. base - voet
	167 x 29 x 29 cm, 0.14 cbm excl. base - voet
A	250 cm, 98.4"
B	210 cm, 65.7"
C	235 cm, 92.5"

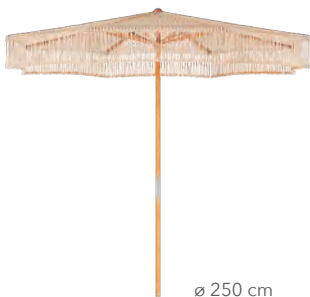

$\varnothing$  250 cm







# CUBA











## CUBA

### UFCUB FRAME - STRUCTURE

	<b>W60</b> eucalyptus
---	-----------------------

### UCCUB CANOPY - TOILE - DOEK

#### CATEGORY 1



	<b>C001</b> natural		<b>C010</b> latte
	<b>C024</b> clay <b>NEW</b>		<b>C101</b> cloud
	<b>C106</b> gris nature		<b>C204</b> night
	<b>C208</b> black		<b>C211</b> steel
	<b>C212</b> gasoline		<b>C301</b> taupe
	<b>C304</b> walnut		

FAST STOCK

#### CATEGORY 2

	<b>C019</b> tofu <b>NEW</b>		<b>C023</b> heather <b>NEW</b>
---	-----------------------------	---	--------------------------------

#### CATEGORY 3

	<b>C003</b> pearl		<b>C011</b> cotton
	<b>C022</b> nile		<b>C207</b> onyx
	<b>C210</b> pitch		<b>C305</b> umber

#### CATEGORY 3

ON DEMAND

see overview fabrics on p. 241 - minimum 3 umbrellas / colour

#### CATEGORY 2

see overview fabrics on p. 242

300 cm - 118.1"

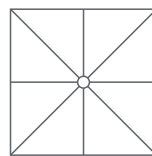

300 cm - 118.1"

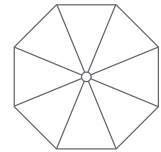

350 cm - 137.8"



300 x 300 cm









ø 350 cm



Mid pole frame, eucalyptus wood.  
 Canopy is weatherproof and colour resistant.  
 Diameter of the pole:  $\varnothing$  61 mm, 2.4".

**UB BASE - VOET**

**BASES WITH OPTIONAL WHEELS**

	<b>LUC-60-NT-B01</b> lucca heavy white
	<b>LUC-60-NT-B06</b> lucca heavy hazel
	<b>LUC-60-NT-B30</b> lucca heavy anthracite
	<b>UABLUC61-A01SP036</b> lucca base tube 61mm white
	<b>UABLUC61-A06SP036</b> lucca base tube 61mm hazel
	<b>UABLUC61-A30SP036</b> lucca base tube 61mm anthracite
OPTIONAL	<b>UALUC-WHE.60</b> lucca light wheels - roues - wielen

**BASES WITH WHEELS**

	<b>ELB-84-S01</b> elba heavy white hot dip galvanized
	<b>ELB-84-S03</b> elba heavy linen hot dip galvanized
	<b>ELB-84-S31</b> elba heavy charcoal hot dip galvanized

**IGB / OGB**

<b>IGB-MP-LARGE</b> in ground base - ancre de sol - grondanker
<b>FFP-MP-LARGE</b> on ground base - plaque de fixation - bevestigingsplaat

**UP COVER - HOUSSE - HOES**

<b>CUB-M</b>
--------------

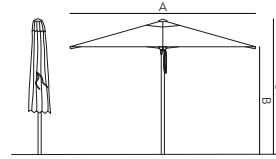

	300 X 300 CM	$\varnothing$ 350 CM
	22 kg - 48.5 lbs nett excl. base	19 kg - 41.9 lbs nett excl. base
A	300 cm - 118.1"	350 cm - 137.8"
B	265 cm - 104.3"	234 cm - 92.1"
C	300 cm - 118.1"	365 cm - 143.7"



# MOOREA











## MOOREA

### UFMOO FRAME - STRUCTURE

	<b>W63</b> teak scratched
---	---------------------------

### UCCUB CANOPY - TOILE - DOEK

#### CATEGORY 1

	<b>C001</b> natural		<b>C010</b> latte
	<b>C024</b> clay <b>NEW</b>		<b>C101</b> cloud
	<b>C106</b> gris nature		<b>C204</b> night
	<b>C208</b> black		<b>C211</b> steel
	<b>C212</b> gasoline		<b>C301</b> taupe
	<b>C304</b> walnut		

FAST STOCK

#### CATEGORY 2

	<b>C019</b> tofu <b>NEW</b>		<b>C023</b> heather <b>NEW</b>
---	-----------------------------	---	--------------------------------

#### CATEGORY 3

	<b>C003</b> pearl		<b>C011</b> cotton
	<b>C022</b> nile		<b>C207</b> onyx
	<b>C210</b> pitch		<b>C305</b> umber

#### CATEGORY 3

ON DEMAND

see overview fabrics on p. 241 - minimum 3 umbrellas / colour
---

#### CATEGORY 2

see overview fabrics on p. 242
--------------------------------

300 cm - 118.1"

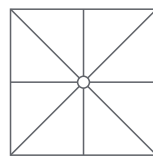

300 cm - 118.1"



300 x 300 cm







Mid pole frame, teak scratched.  
 Canopy is weatherproof and colour resistant.  
 Diameter of the pole: ø 61 mm, 2.4".  
 Frame & canopy are supplied separately to avoid stains.





max. 39 km/h, 24.2 mph

**UB BASE - VOET**

**BASES WITH OPTIONAL WHEELS**

	<b>LUC-60-B01</b> lucca heavy white
	<b>LUC-60-B06</b> lucca heavy hazel
	<b>LUC-60-B30</b> lucca heavy anthracite
	<b>UABLUC61-A01SP036</b> lucca base tube 61mm white
	<b>UABLUC61-A06SP036</b> lucca base tube 61mm hazel
	<b>UABLUC61-A30SP036</b> lucca base tube 61mm anthracite
OPTIONAL	<b>UALUC-WHE.60</b> lucca light wheels - roues - wielen

**BASES WITH WHEELS**

	<b>ELB-84-S01</b> elba heavy white hot dip galvanized
	<b>ELB-84-S03</b> elba heavy linen hot dip galvanized
	<b>ELB-84-S31</b> elba heavy charcoal hot dip galvanized

**IGB / OGB**

<b>IGB-MP-LARGE</b> in ground base - ancre de sol - grondanker
<b>FFP-MP-LARGE</b> on ground base - plaque de fixation - bevestigingsplaat

**UP COVER - HOUSSE - HOES**

<b>CUB-M</b>
--------------

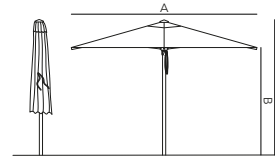

300 X 300 CM	
	28 kg - 61.7 lbs nett excl. base
A	300 cm - 118.1"
B	238 cm - 93.7"
C	272 cm - 107.1"



# BASES

## AZORE BASE silk grey granite

		<b>UBAZO-125-NW</b> silk grey granite		<b>G04</b> light grey granite, bush hammered granit gris clair bouchardé lichtgrijze graniet, gebouchardeerd
OPTIONAL		<b>UBAZO-EW60</b> 2 half tiles 2 demi-tuiles 2 halve tegels		<b>G04</b> light grey granite, bush hammered granit gris clair bouchardé lichtgrijze graniet, gebouchardeerd
		<b>UABTEN-SP037-SET</b>		set of 4 stainless steel wheels
		<b>UABANT-SP037(A)-SET</b>		set of 4 synthetic wheels

base	
nett weight	125 kg, 275.6 lbs
gross weight	128 kg, 282.2 lbs
	81 x 81 x 20 cm, 1 cbm

## ANTEGO BASE silk grey granite

		<b>UBANT-125-NW</b> silk grey granite		<b>G04</b> light grey granite, bush hammered granit gris clair bouchardé lichtgrijze graniet, gebouchardeerd
OPTIONAL		<b>UBANT-EW60</b> 2 half tiles 2 demi-tuiles 2 halve tegels		<b>G04</b> light grey granite, bush hammered granit gris clair bouchardé lichtgrijze graniet, gebouchardeerd
		<b>UABTEN-SP037-SET</b>		set of 4 stainless steel wheels
		<b>UABANT-SP037(A)-SET</b>		set of 4 synthetic wheels

base	
nett weight	125 kg, 275.6 lbs
gross weight	128 kg, 282.2 lbs
	94 x 94 x 18 cm, cbm





# BASES

## ANTEGO BASE black granite

		<b>UBANT-125-NW</b> black granite		<b>G32</b> black granite, bush hammered granit noir bouchardé zwart graniet, gebouchardeerd
OPTIONAL		<b>UABTEN-SP037-SET</b>		set of 4 stainless steel wheels
		<b>UABANT-SP037(A)-SET</b>		set of 4 synthetic wheels







	base
nett weight	125 kg, 275.6 lbs
gross weight	128 kg, 282.2 lbs
	94 x 94 x 18 cm, 0.14 cbm

## ANTEGO BASE sandstone

		<b>UBANT-125-NW</b> silk grey granite		<b>G13</b> Egyptian sandstone with sandblasted finish
OPTIONAL		<b>UABTEN-SP037-SET</b>		set of 4 stainless steel wheels
		<b>UABANT-SP037(A)-SET</b>		set of 4 synthetic wheels







	base
nett weight	125 kg, 275.6 lbs
gross weight	132 kg, 291 lbs
	94 x 94 x 18 cm, 0.14 cbm

## ANTEGO BASE concrete

		<b>UBANT-125-NW</b> concrete		<b>B01</b> white
				<b>B03</b> linen
				<b>B30</b> anthracite
OPTIONAL		<b>UABTEN-SP037-SET</b>		set of 4 stainless steel wheels
		<b>UABANT-SP037(A)-SET</b>		set of 4 synthetic wheels

	base
nett weight	125 kg, 275.6 lbs
gross weight	130 kg, 286.6 lbs
	94 x 94 x 18 cm, 0.14 cbm

## ANTEGO BASE powder coated steel





		<b>UBANT-125</b> powder coated steel		<b>S01</b> white
				<b>S03</b> linen
				<b>S30</b> anthracite
				<b>S32</b> black
				stainless steel chemical anchored

	base
nett weight	125 kg, 275.6 lbs
gross weight	130 kg, 286.6 lbs









# BASES

## LIMA BASE silk grey granite

	<b>UBLIM-300</b> silk grey granite		<b>G04</b> light grey granite, bush hammered granit gris clair bouchardé lichtgrijze graniet, gebouchardeerd
			





	base
nett weight	300 kg, 661.4 lbs
gross weight	305 kg, 672.4 lbs
	x x cm, cbm

## LIMA BASE half base

	<b>UBLIM-HAL</b> powder coated aluminium cover		<b>A01</b> white
			<b>A03</b> linen
			<b>A30</b> anthracite
			<b>A32</b> black
	base		
	12 granite tiles of 20 kg		<b>XXX</b> granite





	base
nett weight	318 kg, 661.4 lbs
gross weight	320 kg, 705.5 lbs
	130 x 54 x 22.5 cm, 0.2 cbm

## TULI BASE Tuli

	<b>UBTUL-50</b> concrete		<b>B01</b> white
			<b>B03</b> linen
			<b>B32</b> black
	<b>UAB</b>		

	base
nett weight	50 kg, 110.2 lbs
gross weight	52 kg, 114.6 lbs
	74 x 67 x 13.5 cm, cbm





## ELBA MEDIUM Amalfi, Tuli

	<b>UBELB-44</b> metallised & powder coated steel		<b>S01</b> white
			<b>S03</b> linen
			<b>S31</b> charcoal
	<b>UABELB-SP037</b>		

	base
nett weight	44 kg, 97 lbs
gross weight	46 kg, 101 lbs
	77.5 x 65 x 11 cm, cbm





# BASES

## ELBA HEAVY Cuba, Moorea

	<b>UBELB-44</b> metallised & powder coated steel	 <b>S01</b> white
		 <b>S03</b> linen
		 <b>S31</b> charcoal
	<b>UABELB-SP037</b>	









	base
nett weight	84 kg, 185.2 lbs
gross weight	88 kg, 194 lbs
	99.5 x 86 x 12 cm, cbm

## LUCCA LIGHT

	<b>UBLUC-35</b> concrete  adaptor rings: ø 18 - 50 mm	 <b>B01</b> white
		 <b>B06</b> hazel
		 <b>B30</b> anthracite
<b>OPTIONAL</b> 	<b>UALUC-WHE.35</b>	









	base
nett weight	35 kg, 77.2 lbs
gross weight	40 kg, 88.2 lbs
	cm, cbm

## LUCCA HEAVY ø 61MM Cuba, Moorea

	<b>UBLUC-60-NT</b> concrete	 <b>B01</b> white
		 <b>B06</b> hazel
		 <b>B30</b> anthracite
<b>OPTIONAL</b> 	<b>UABLUC61</b>	 <b>A01SP036</b> white
		 <b>A06SP036</b> hazel
		 <b>A30SP036</b> anthracite
	<b>UALUC-WHE.60</b>	

	base
nett weight	60 kg, 132.3 lbs
gross weight	65 kg, 143.3 lbs
	cm, cbm

## LUCCA HEAVY ø 25-55MM Amalfi, Tuli

	<b>UBLUC-60-NT</b> concrete	 <b>B01</b> white
		 <b>B06</b> hazel
		 <b>B30</b> anthracite
<b>OPTIONAL</b> 	<b>UABLUC25/55</b>	 <b>A01SP036</b> white
		 <b>A06SP036</b> hazel
		 <b>A30SP036</b> anthracite
	<b>UALUC-WHE.60</b>	

	base
nett weight	60 kg, 132.3 lbs
gross weight	65 kg, 143.3 lbs
	cm, cbm



# BASES

## IN GROUND BASE

### UBBS-MP-SMALL MID POLE SMALL Tuli

	beach spike aluminium
---	--------------------------

### UBIGB-MP-SM MID POLE SMALL MEDIUM

Amalfi, Tuli

	aluminium
---	-----------

### UBIGB-MP-LARGE MID POLE LARGE Cuba, Moorea

	6 kg, 13 lbs ø 7 x 67 cm, 2.8 x 26.4" steel - acier - staal
---	---

### UBIGB-AZO-4G-MEDIUM AZORE Azore

	5.7 kg, 12.6 lbs ø 21.5 x 51 cm, 8.5 x 20.1" steel - acier - staal
--	--

### UBIGB-FP-4G-MEDIUM ANTEGO Antego

	5.7 kg, 12.6 lbs ø 21.5 x 51 cm, 8.5 x 20.1" steel - acier - staal
---	--

### UBIGB-LIM-4G-LARGE LIMA Lima

	8.4 kg, 18.5 lbs ø 25 x 51 cm, 9.8 x 20.1" steel - acier - staal
---	--

## ON GROUND BASE

### UBOGB-MP-LARGE MID POLE LARGE Cuba, Moorea

	8.4 kg, 18.5 lbs 30 x 30 x 44 cm, 11.8 x 11.8 x 17.3" aluminium anodised - anodisé - geanodiseerd
--	--

### UBOGB-AZO-4G-MEDIUM MID POLE MEDIUM Azore

	8 kg, 17.6 lbs ø 21.5 x 2.1 cm, 8.5 x 0.5" steel - acier - staal
--	--

### UBOGB-FP-4G-MEDIUM FREE POLE MEDIUM

Antego

	8 kg, 17.6 lbs ø 21.5 x 2.1 cm, 8.5 x 0.5" steel - acier - staal
--	--

### UBOGB-LIM-4G-LARGE FREE POLE LARGE Lima

	8 kg, 17.6 lbs ø 21.5 x 1.2 cm, 8.5 x 0.5" steel - acier - staal
---	--







# TATAMI

## NEW

Teak frame with hand woven strap.  
 Seat with teak.  
 Cushions are weatherproof and colour resistant.  
 Table top in solid teak.

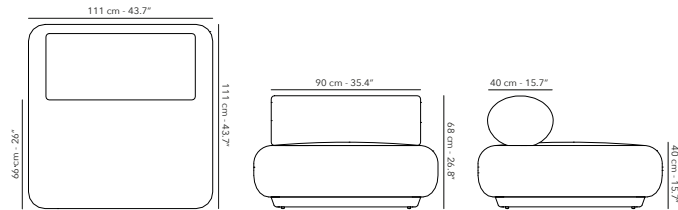

### LOUNGE CHAIR 1S MIDDLE SEAT

	FUTATMS03 frame & cushions	 W62 teak	29.4 kg 64.8 lbs
		 fabric of choice	



Find an overview on p. 247  
 Protection cover available.

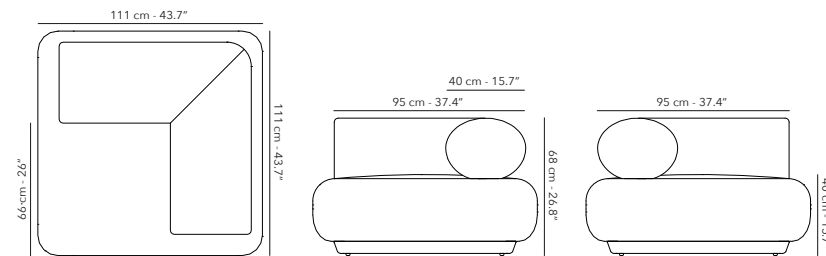

### LOUNGE CHAIR 1S WITH CORNER

	FUTATMSC01 frame & cushions	 W62 teak	33 kg 72.8 lbs
		 fabric of choice	



Find an overview on p. 247  
 Protection cover available.

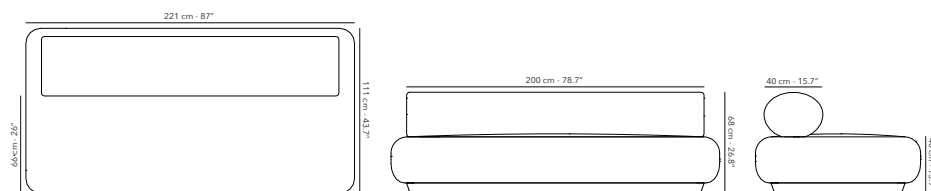

### SOFA 3S MIDDLE SEAT

	FUTATTS01 frame & cushions	 W62 teak	57.8 kg 127.4 lbs
		 fabric of choice	



Find an overview on p. 247  
 Protection cover available.

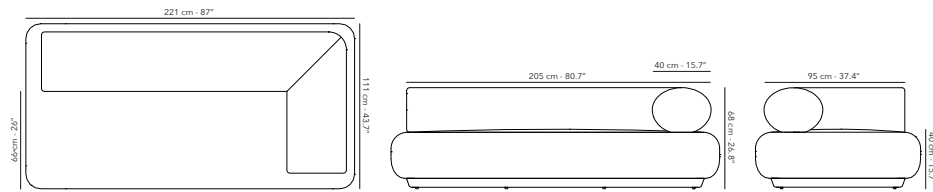

**SOFA 3S WITH LEFT CORNER**

	<b>FUTATSLC01</b> frame & cushions	 <b>W62 teak</b>	61.1 kg 134.7 lbs
		 fabric of choice	



Find an overview on p. 247  
Protection cover available.

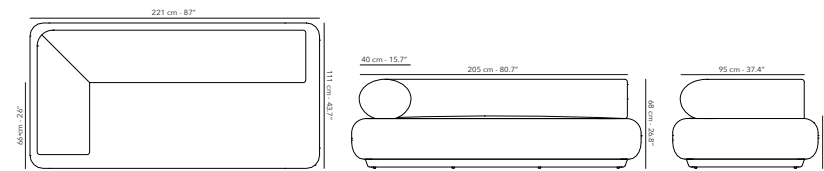

**SOFA 3S WITH RIGHT CORNER**

	<b>FUTATSRC01</b> frame & cushions	 <b>W62 teak</b>	61.1 kg 134.7 lbs
		 fabric of choice	



Find an overview on p. 247  
Protection cover available.

**DAYBED**

	<b>FUTATDB06</b> frame & cushions	 <b>W62 teak</b>	66.5 kg 146.6 lbs
		 fabric of choice	

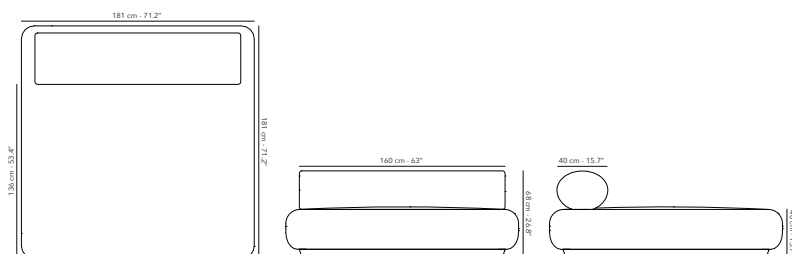

Find an overview on p. 247  
Protection cover available.



# TONDO

## UPDATED

Powder coated aluminium frame with multicoloured rope 30 mm.  
Cushions are weatherproof and colour resistant.  
Table top is made of solid teak or ceramic 12 mm.

### DINING ARMCHAIR

NEW



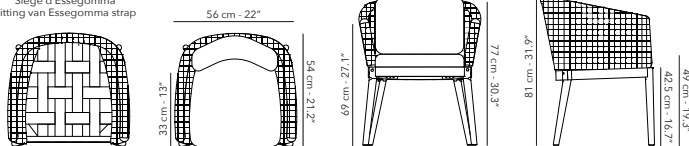

		<b>FUTONAC13</b> cushions - coussins - kussens		<b>W62R05</b> teak & seal	8.6 kg 9 lbs
		<b>CUTONAC13</b> cushions - coussins - kussens		<b>C016</b> pampas cat. C quick dry foam 	
	<b>OPTIONAL</b>	<b>CUTONBAAC13</b> back cushion - coussin de dos - rugkussen		<b>C016</b> pampas cat. C quick dry foam 	

Other fabrics upon request.  
Find an overview on p. 247  
Protection cover available.

Seat with Essegomma strap  
Siège d'Essegomma  
Zitting van Essegomma strap



### LOUNGE CHAIR 15

		<b>FUTON1S09</b> frame - structure		<b>A03R05</b> linen & seal	27.2 kg 36.5 lbs
	<b>QUICK DRY</b>	<b>CUTON1S09</b> cushions - coussins - kussens		<b>C016</b> pampas cat. C	
	<b>COMFORT</b>	<b>CUTON1S09-CF</b> cushions - coussins - kussens		<b>C016</b> pampas cat. C 	

360° rotation through the swivel system.  
Other fabrics upon request.  
Find an overview on p. 247  
Protection cover available.

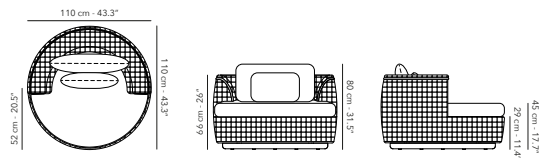

### SOFA 3S

		<b>FUTON3S08</b> frame - structure		<b>A03R05</b> linen & seal	 65.5 kg 144.4 lbs
	<b>QUICK DRY</b>	<b>CUTON3S08</b> cushions - coussins - kussens		<b>C016</b> pampas cat. C	
	<b>COMFORT</b>	<b>CUTON3S08-CF</b> cushions - coussins - kussens		<b>C016</b> pampas cat. C 	

Other fabrics upon request.  
Find an overview on p. 247  
Protection cover available.

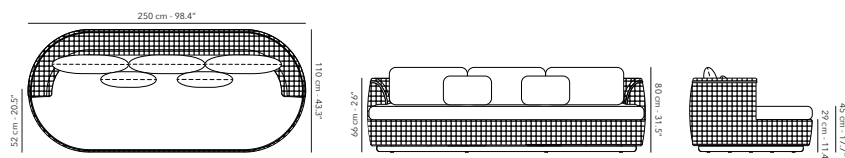

# TONDO

## MODULAR ORGANIC SOFA ISLAND left arm

	<b>QUICK DRY</b>	<b>FUTONSI01LA</b> frame - structure		<b>A03R05</b> linen & seal
	<b>COMFORT</b>	<b>CUTONSI01LA</b> cushions - coussins - kussens		<b>C016</b> pampas cat. C
		<b>CUTONSI01LA-CF</b> cushions - coussins - kussens		<b>C016</b> pampas cat. C

54.7 kg  
120.6 lbs

Other fabrics upon request.  
Find an overview on p. 247  
Protection cover available.

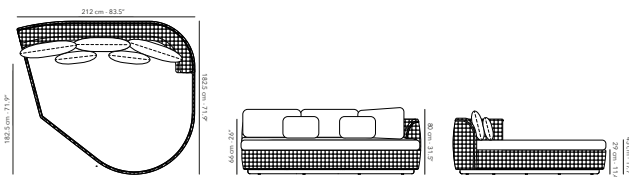

## MODULAR ORGANIC SOFA ISLAND right arm

	<b>QUICK DRY</b>	<b>FUTONSI01RA</b> frame - structure		<b>A03R05</b> linen & seal
	<b>COMFORT</b>	<b>CUTONSI01RA</b> cushions - coussins - kussens		<b>C016</b> pampas cat. C
		<b>CUTONSI01RA-CF</b> cushions - coussins - kussens		<b>C016</b> pampas cat. C

54.7 kg  
120.6 lbs

Other fabrics upon request.  
Find an overview on p. 247  
Protection cover available.

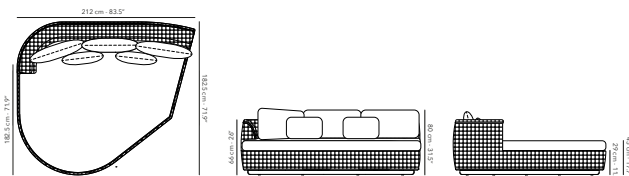

## MODULAR ORGANIC SOFA 2.5S left arm

	<b>QUICK DRY</b>	<b>FUTON2S09LA</b> frame - structure		<b>A03R05</b> linen & seal
	<b>COMFORT</b>	<b>CUTON2S09LA</b> cushions - coussins - kussens		<b>C016</b> pampas cat. C
		<b>CUTON2S09LA-CF</b> cushions - coussins - kussens		<b>C016</b> pampas cat. C

45.4 kg  
100.1 lbs



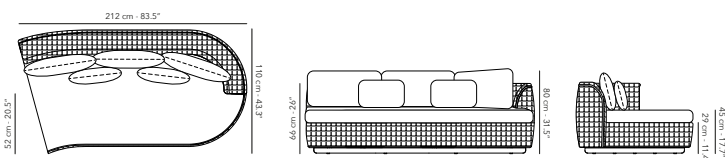

Other fabrics upon request.  
Find an overview on p. 247  
Protection cover available.





# TONDO

## MODULAR ORGANIC SOFA 2.5S right arm



	<b>QUICK DRY</b> COMFORT	<b>FUTON2S09RA</b> frame - structure		<b>A03R05</b> linen & seal
		<b>CUTON2S09RA</b> cushions - coussins - kussens		<b>C016</b> pampas cat. C
		<b>CUTON2S09RA-CF</b> cushions - coussins - kussens		<b>C016</b> pampas cat. C 

 45.4 kg  
100.1 lbs

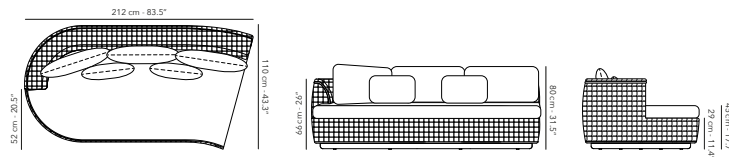
Other fabrics upon request.  
Find an overview on p. 247  
Protection cover available.





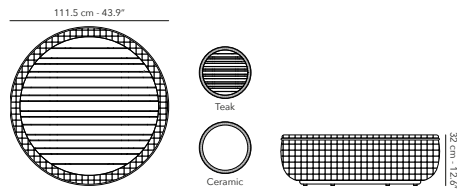

## COFFEE TABLE ø 110 cm

	<b>FUTONLT11</b> frame - structure		<b>A03R05</b> linen & seal
	<b>FUTONTOP11</b> table top - plateau - tafelblad		<b>W62</b> teak
			<b>K14</b> taupegrey

 **W62**  
21.3 kg  
47 lbs



## SIDE TABLE ø 45 cm



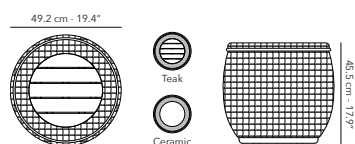

	<b>FUTONST10</b> frame - structure		<b>A03R05</b> linen & seal
	<b>FUTONTOP10</b> table top - plateau - tafelblad		<b>W62</b> teak
			<b>K14</b> taupegrey

 **W62**  
6.9 kg  
15.2 lbs



# TONDO

## DAYBED



		<b>FUTONDB04</b> frame - structure		<b>A03R05</b> linen & seal
	QUICK DRY	<b>CUTONDB04</b> cushions - coussins - kussens		<b>C016</b> pampas cat. C
	COMFORT	<b>CUTONDB04-CF</b> cushions - coussins - kussens		<b>C016</b> pampas cat. C 

 65.9 kg  
145.3 lbs

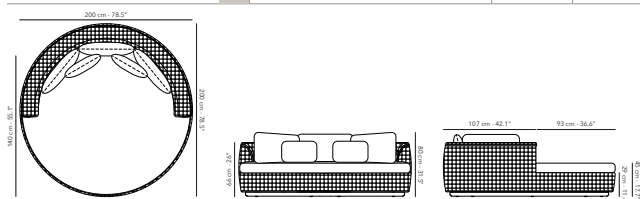
Other fabrics upon request.  
Find an overview on p. 247  
Protection cover available.



## PRANA BASKET set

	<b>DEBASPRA-SET</b> frame - structure		<b>D05</b> seal
--	--	---	-----------------

13.7 kg  
16.5 lbs

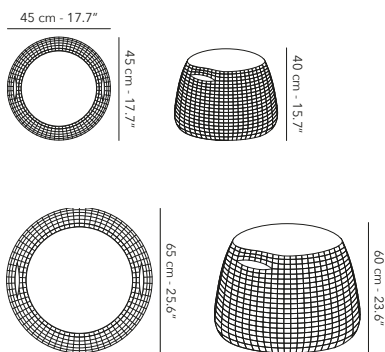





COMO

Eps finished with a mixture of chalk and concrete applied by hand and spatula.  
 Table top 25 mm.  
 Waterproof- & repellent.

**ORGANIC DINING TABLE** ø 160 cm

	<p><b>FUCOMDT09</b> frame - structure</p>		<p><b>X01 mist</b></p>
---	---	---	------------------------

91.3 kg  
201.3 lbs

Protection cover available.

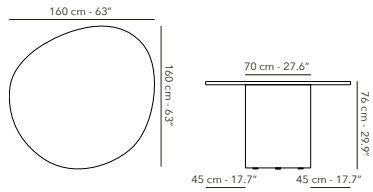

**ORGANIC DINING TABLE** 260 x 120 cm



	<p><b>FUCOMDT44</b> frame - structure</p>		<p><b>X01 mist</b></p>
--	---	--	------------------------

93 kg  
205 lbs

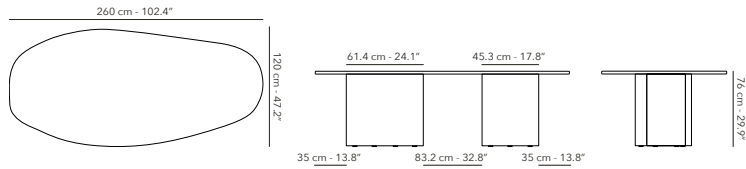
Protection cover available.



**ROUND NESTING COFFEE TABLE** ø 90 cm

	<p><b>FUCOMLT19</b> frame - structure</p>		<p><b>X01 mist</b></p>
---	---	---	------------------------

27.9 kg  
61.5 lbs

Protection cover available.

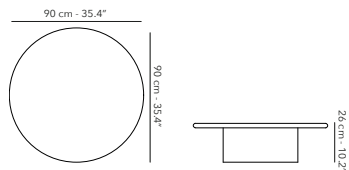

**ORGANIC NESTING COFFEE TABLE** 145 x 100 cm

	<p><b>FUCOMLT20</b> frame - structure</p>		<p><b>X01 mist</b></p>
---	---	---	------------------------

48.5 kg  
106.9 lbs

Protection cover available.

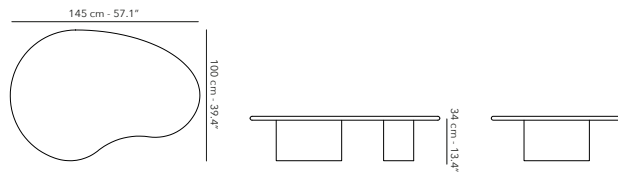

**ORGANIC NESTING SIDE TABLE** 50 x 40 cm

	<p><b>FUCOMST14</b> frame - structure</p>		<p><b>X01 mist</b></p>
--	---	--	------------------------

11 kg  
24.3 lbs

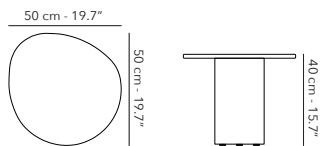

**ORGANIC NESTING SIDE TABLE** 50 x 50 cm

	<p><b>FUCOMST15</b> frame - structure</p>		<p><b>X01 mist</b></p>
---	---	---	------------------------

12 kg  
26.5 lbs

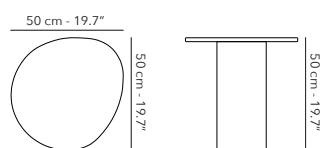







# NOA

Designed by Enrique Marti

Teak frame with hand woven strap.  
 Seat with teak.  
 Cushions are weatherproof and colour resistant.  
 Table top in solid teak.

## DINING CHAIR



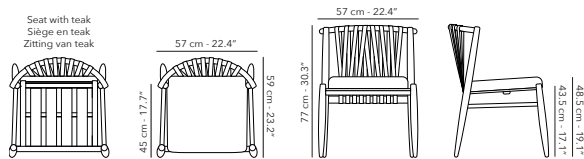

	<b>FUNOANC08</b> frame - structure		<b>W62R11</b> teak & artichoke
	<b>CUNOA(N)AC08</b> cushion - coussin - kussen		<b>C015</b> brûlé cat. D
	<b>OPTIONAL</b> <b>CUNOABA(N)AC08</b> back cushion - coussin de dos - rugkussen		<b>C015</b> brûlé cat. D

 6.8 kg  
15 lbs

Other fabrics upon request.  
 Find an overview on p. 247  
 Protection cover available.



## DINING ARMCHAIR

	<b>FUNOAAC08</b> frame - structure		<b>W62R11</b> teak & artichoke
	<b>CUNOA(N)AC08</b> cushion - coussin - kussen		<b>C015</b> brûlé cat. D
	<b>OPTIONAL</b> <b>CUNOABA(N)AC08</b> back cushion - coussin de dos - rugkussen		<b>C015</b> brûlé cat. D

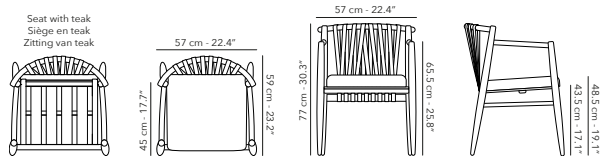

 7.7 kg  
17 lbs

Other fabrics upon request.  
 Find an overview on p. 247  
 Protection cover available.



## BAR TABLE 200 x 100 cm

**NEW**

	<b>FUNOABT03</b> frame - structure		<b>W62</b> teak

 57.2 kg  
126 lbs

Protection cover available.

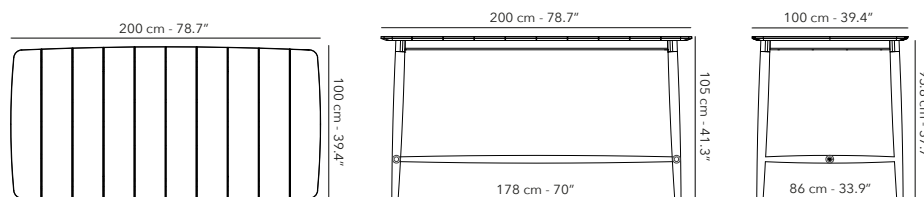

**DINING TABLE** 200 x 100 cm



	<p><b>FUNOADT43</b> frame - structure</p>		<p><b>W62 teak</b></p>
---	---	---	------------------------

 49.5 kg  
 109.1 lbs

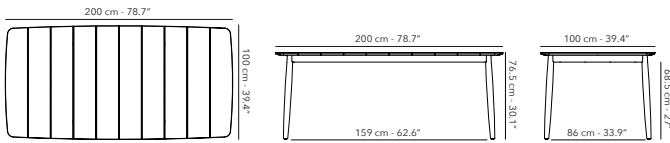
Protection cover available.



**DINING TABLE** 270 x 100 cm



	<p><b>FUNOADT46</b> frame - structure</p>		<p><b>W62 teak</b></p>
--	---	--	------------------------

 72.4 kg  
 159.6 lbs

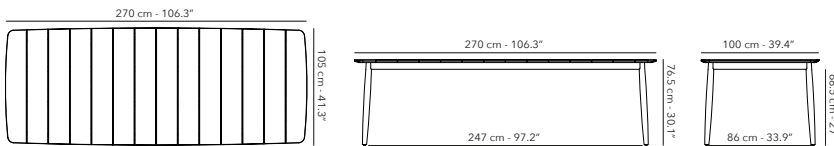
Protection cover available.



**DINING TABLE** 340 x 100 cm

	<p><b>FUNOADT50</b> frame - structure</p>		<p><b>W62 teak</b></p>
---	---	---	------------------------

 103.9 kg  
 229.1 lbs



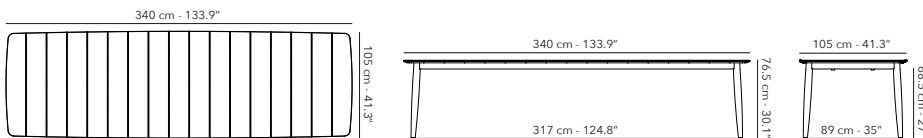





Protection cover available.





# NOA

## LOUNGE CHAIR 1S







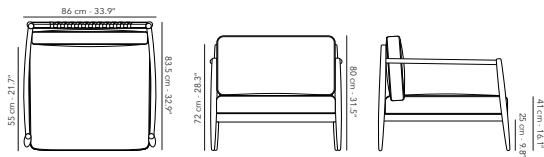

	<b>QUICK DRY</b> CUNOA1S06 cushions - coussins - kussens	 W62R11 teak & artichoke
		 C015 brûlé cat. D 
		 C111 truffle cat. D 
<b>COMFORT</b> CUNOA1S06-CF cushions - coussins - kussens	 C015 brûlé cat. D	
	 C111 truffle cat. D	

 20.2 kg  
44.5 lbs

Other fabrics upon request.  
Find an overview on p. 247  
Protection cover available.



## SOFA 2S







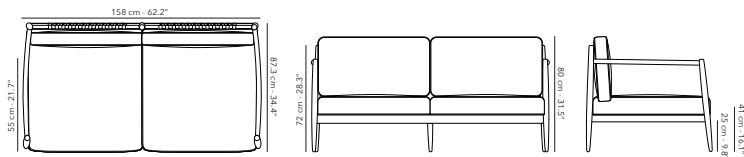

	<b>QUICK DRY</b> 2x CUNOA1S06 cushions - coussins - kussens	 W62R11 teak & artichoke
		 C015 brûlé cat. D 
		 C111 truffle cat. D 
<b>COMFORT</b> 2x CUNOA1S06-CF cushions - coussins - kussens	 C015 brûlé cat. D	
	 C111 truffle cat. D	

 36.4 kg  
80.3 lbs

Other fabrics upon request.  
Find an overview on p. 247  
Protection cover available.



## SOFA 3S



	<b>QUICK DRY</b> 3x CUNOA1S06 cushions - coussins - kussens	 W62R11 teak & artichoke
		 C015 brûlé cat. D 
		 C111 truffle cat. D 
<b>COMFORT</b> 3x CUNOA1S06 cushions - coussins - kussens	 C015 brûlé cat. D	
	 C111 truffle cat. D	

 53.7 kg  
118.4 lbs

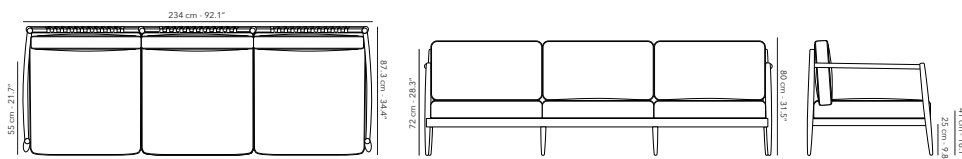
Other fabrics upon request.  
Find an overview on p. 247  
Protection cover available.



**COFFEE TABLE** 125 x 75 cm



	<p><b>FUNOALT10</b> frame</p>		<p><b>W62 teak</b></p>
---	-----------------------------------	---	------------------------

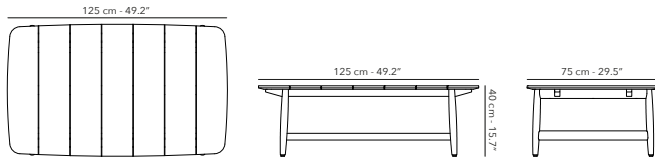

23.5 kg  
51.8 lbs



**SIDE TABLE** 50 x 50 cm



	<p><b>FUNOAST08</b> frame</p>		<p><b>W62 teak</b></p>
--	-----------------------------------	--	------------------------

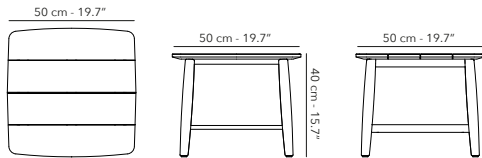

6.4 kg  
14.1 lbs



**SOFA SIDE TABLE**

	<p><b>FUNOASST01</b> frame</p>		<p><b>W62 teak</b></p>
---	------------------------------------	---	------------------------





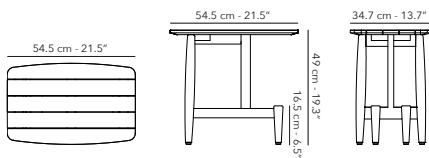





4.3 kg  
9.5 lbs





# NOA





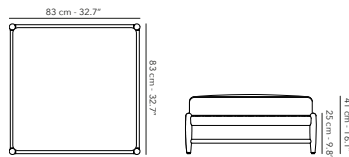



## OTTOMAN

	<b>QUICK DRY</b> COMFORT	<b>FUNOAOT02</b> frame - structure	 <b>W62</b> teak
		<b>CUNOAOT02</b> cushions - coussins - kussens	 <b>C015</b> brulé cat. D   <b>C111</b> truffe cat. D 
		<b>CUNOAOT02-CF</b> cushions - coussins - kussens	 <b>C015</b> brulé cat. D  <b>C111</b> truffe cat. D



Other fabrics upon request.  
Find an overview on p. 247  
Protection cover available.





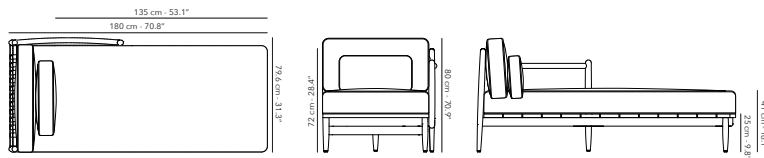



## CHAISE LONGUE left arm

	<b>QUICK DRY</b> COMFORT	<b>FUNOACL05LA</b> frame - structure	 <b>W62R11</b> teak & artichoke
		<b>CUNOACL05LA</b> cushions - coussins - kussens	 <b>C015</b> brulé cat. D   <b>C111</b> truffe cat. D 
		<b>CUNOACL05LA-CF</b> cushions - coussins - kussens	 <b>C015</b> brulé cat. D  <b>C111</b> truffe cat. D



Other fabrics upon request.  
Find an overview on p. 247  
Protection cover available.





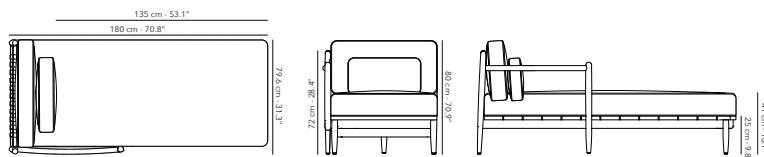



## CHAISE LONGUE right arm

	<b>QUICK DRY</b> COMFORT	<b>FUNOACL05RA</b> frame - structure	 <b>W62R11</b> teak & artichoke
		<b>CUNOACL05RA</b> cushions - coussins - kussens	 <b>C015</b> brulé cat. D   <b>C111</b> truffe cat. D 
		<b>CUNOACL05RA-CF</b> cushions - coussins - kussens	 <b>C015</b> brulé cat. D  <b>C111</b> truffe cat. D



Other fabrics upon request.  
Find an overview on p. 247  
Protection cover available.

**SUNLOUNGER**

	<b>FUNOASL06</b> frame - structure	 <b>W62 teak</b>
	<b>QUICK DRY</b> <b>CUNOASL06-2.0</b> cushions - coussins - kussens	 <b>C015 brûlé cat. D</b>   <b>C111 truffe cat. D</b> 
	<b>COMFORT</b> <b>CUNOASL06-2.0-CF</b> cushions - coussins - kussens	 <b>C015 brûlé cat. D</b>  <b>C111 truffe cat. D</b>

Other fabrics upon request.  
 Find an overview on p. 247  
 Protection cover available.

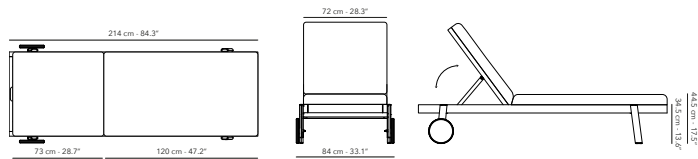

**DIVIDER H 150 cm**

	<b>FUNOADIV150 (low)</b> frame - structure	 <b>W62R11</b> teak & artichoke	41.8 kg 92.2 lbs
--	---	--	---------------------

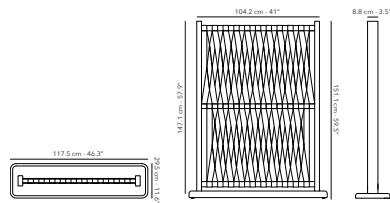

**DIVIDER H 180 cm**

	<b>FUNOADIV180 (high)</b> frame - structure	 <b>W62R11</b> teak & artichoke	45.8 kg 100.9 lbs
---	--	---	----------------------

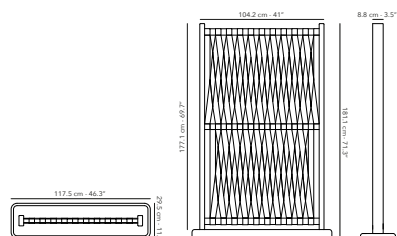











# TUGU

Aluminium frame with hand woven wicker 6 mm.  
 Seat with Essegomma strap 50 mm.  
 Table top is made of (sable) solid teak or ceramic 12 mm.





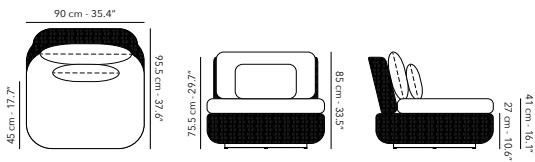

## SOFA 1S

		<b>FUTUG1S03</b> frame - structure		<b>F16 cottage</b>	   30 kg 66 lbs
	<b>Q. DRY</b>	<b>CUTUG1S03</b> cushions - coussins - kussens		<b>C008</b> linen cat. B 	
	<b>COMF.</b>	<b>CUTUG1S03-CF</b> cushions - coussins - kussens		<b>C008</b> linen cat. B	

360° rotation through the swivel system.  
 Other fabrics upon request.  
 Find an overview on p. 247  
 Protection cover available.







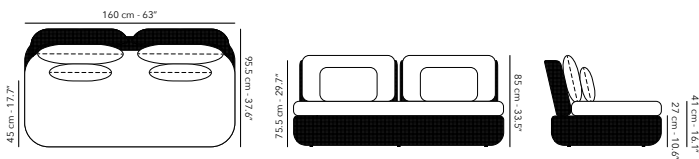

## SOFA 2S

		<b>FUTUG2S03</b> frame - structure		<b>F16 cottage</b>	  41.5 kg 91.5 lbs
	<b>Q. DRY</b>	<b>CUTUG2S03</b> cushions - coussins - kussens		<b>C008</b> linen cat. B 	
	<b>COMF.</b>	<b>CUTUG2S03-CF</b> cushions - coussins - kussens		<b>C008</b> linen cat. B	

Other fabrics upon request.  
 Find an overview on p. 247  
 Protection cover available.







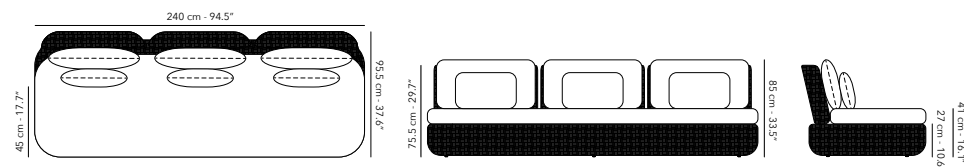

## SOFA 3S

		<b>FUTUG3S03</b> frame - structure		<b>F16 cottage</b>	  60 kg 132.3 lbs
	<b>Q. DRY</b>	<b>CUTUG3S03</b> cushions - coussins - kussens		<b>C008</b> linen cat. B 	
	<b>COMF.</b>	<b>CUTUG3S03-CF</b> cushions - coussins - kussens		<b>C008</b> linen cat. B	

Other fabrics upon request.  
 Find an overview on p. 247  
 Protection cover available.







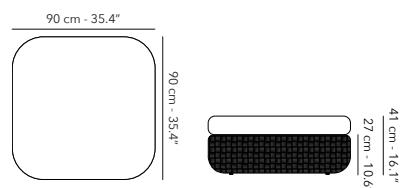

## OTTOMAN 90 x 90 cm

		<b>FUTUGOT01</b> frame - structure		<b>F16</b> cottage	 13.7 kg 30.2 lbs
	<b>Q. DRY</b>	<b>CUTUGOT01</b> cushions - coussins - kussens		<b>C008</b> linen cat. B 	
	<b>COMF.</b>	<b>CUTUGOT01-CF</b> cushions - coussins - kussens		<b>C008</b> linen cat. B	







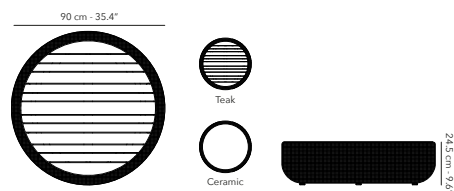

## COFFEE TABLE ø 90 cm

		<b>FUTUGLT08S</b> frame - structure		<b>F16</b> cottage	 <b>W62 &amp; W64</b> 13 kg 28.6 lbs
		<b>FUTUGTOP04</b> Table top plateau tafelblad		<b>W62</b> teak	
				<b>W64</b> sable teak	
				<b>K14</b> taupegrey	



## COFFEE TABLE ø 120 cm

		<b>FUTUGLT07S</b> frame - structure		<b>F16</b> cottage	 <b>W62 &amp; W64</b> 19 kg 42 lbs
		<b>FUTUGTOP06</b> Table top plateau tafelblad		<b>W62</b> teak	
				<b>W64</b> sable teak	
				<b>K14</b> taupegrey	

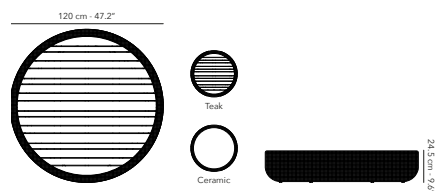



# TUGU

## SIDE TABLE ø 45 cm

	<b>FUTUGST05S</b> frame - structure		<b>F16</b> cottage
	<b>FUTUGTOP05</b> Table top plateau tafelblad		<b>W62</b> teak
			<b>W64</b> sable teak
			<b>K14</b> taupegrey



**W62 & W64**  
5.3 kg  
11.6 lbs

45 cm - 17.7"



Teak







Ceramic



37 cm - 14.6"

## SUNLOUNGER





	<b>FUTUGSL02</b> frame - structure		<b>F16</b> cottage
	<b>CUTUGSL02</b> cushions - coussins - kussens		<b>C008</b> linen cat. B 
	<b>CUTUGSL02-CF</b> cushions - coussins - kussens		<b>C008</b> linen cat. B

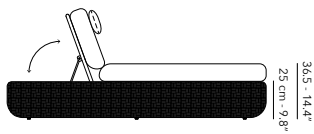
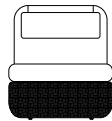
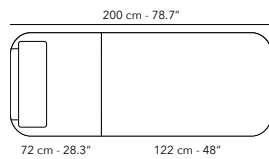

30 kg  
66 lbs



## DAYBED

	<b>FUTUGDB05</b> frame - structure		<b>F16</b> cottage
	<b>CUTUGDB05</b> cushions - coussins - kussens		<b>C008</b> linen cat. B 
	<b>CUTUGDB05-CF</b> cushions - coussins - kussens		<b>C008</b> linen cat. B



43.2 kg  
95.2 lbs

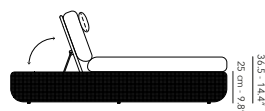
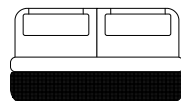
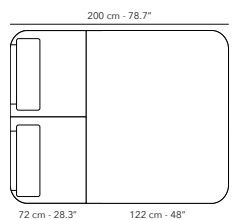



## POTTERY SMALL ø 45 cm

	<p><b>DEPOTTUG45.S</b> frame - structure</p>		<p>F16 cottage</p>
---	--	---	--------------------

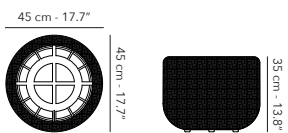
3.8 kg  
8.4 lbs



## POTTERY MEDIUM ø 65 cm

	<p><b>DEPOTTUG65.M</b> frame - structure</p>		<p>F16 cottage</p>
--	--	---	--------------------

7.3 kg  
16.1 lbs

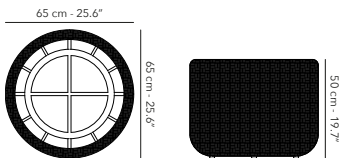

## POTTERY LARGE ø 85 cm

	<p><b>DEPOTTUG85.L</b> frame - structure</p>		<p>F16 cottage</p>
---	--	---	--------------------

11.5 kg  
25.4 lbs

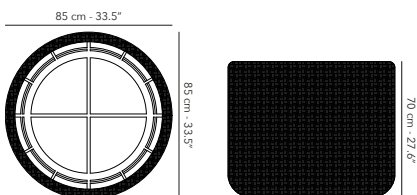



# LEGNA

(Sable) teak frame with hand woven rope 10 mm.  
 Cushions are weatherproof and colour resistant.  
 Table top is made of ceramic 12 mm.  
 Teak care kit available.

## DINING ARMCHAIR

	<b>FULEGAC06-2.0</b> frame - structure		<b>W64R12</b> sable teak & cream
	<b>CULEGAC06-2.0</b> cushions - coussins - kussens		<b>C012</b> cream cat. C

9.2 kg  
 20.3 lbs

Other fabrics upon request.  
 Find an overview on p. 247  
 Protection cover available.

Seat with Essegomma strap  
 Siège d'Essegomma  
 Zitting van Essegomma strap

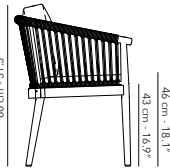
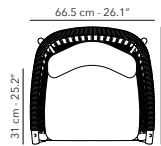
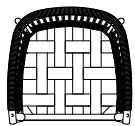

# LEGNA

## DINING TABLE 160 x 100 cm





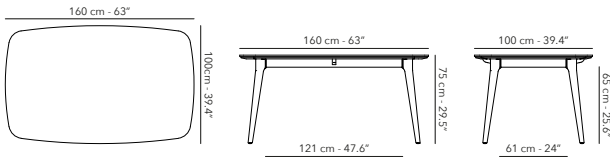

	<b>FULEGDT41S</b> frame - structure		<b>W64</b> sable teak
	<b>FULEGTOP41</b> table top plateau tafelblad	 	<b>K02</b> bianco <b>K14</b> taupegrey

 71.7 kg  
158.1 lbs



## DINING TABLE 240 x 100 cm

UPDATED





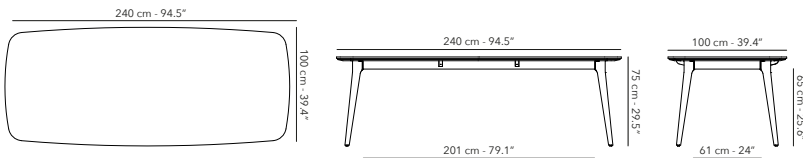

	<b>FULEGDT44S</b> frame - structure	 	<b>W62</b> teak <b>W64</b> sable teak
	<b>FULEGTOP44</b> table top plateau tafelblad	  	<b>K02</b> bianco <b>K12</b> earth <b>NEW</b> <b>K14</b> taupegrey

 100.2 kg  
220.8 lbs



## DINING TABLE 320 x 100 cm

UPDATED

	<b>FULEGDT49S</b> frame - structure	 	<b>W62</b> teak <b>W64</b> sable teak
	<b>FULEGTOP49</b> table top plateau tafelblad	  	<b>K02</b> bianco <b>K12</b> earth <b>NEW</b> <b>K14</b> taupegrey





 128.3 kg  
282.9 lbs





# LEGNA



## LOUNGE CHAIR 1S

		<b>FULEG1S04</b> frame - structure		<b>W64R12</b> sable teak & cream	14 kg 31 lbs
	Q. DRY	<b>CULEG1S04</b> cushions - coussins - kussens		<b>C012</b> cream cat. C 	
	COMF.	<b>CULEG1S04-CF</b> cushions - coussins - kussens		<b>C012</b> cream cat. C	

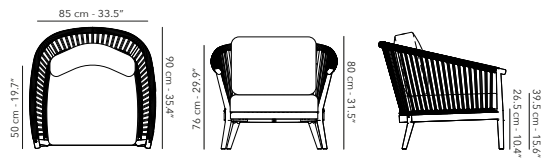
Other fabrics upon request.  
Find an overview on p. 247  
Protection cover available.





## SOFA 2.5S

		<b>FULEG2S04</b> frame - structure		<b>W64R12</b> sable teak & cream	28.6 kg 63 lbs
	Q. DRY	<b>CULEG2S04</b> cushions - coussins - kussens		<b>C012</b> cream cat. C 	
	COMF.	<b>CULEG2S04-CF</b> cushions - coussins - kussens		<b>C012</b> cream cat. C	

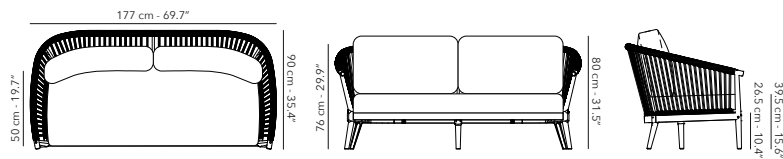
Other fabrics upon request.  
Find an overview on p. 247  
Protection cover available.



## SOFA 3S

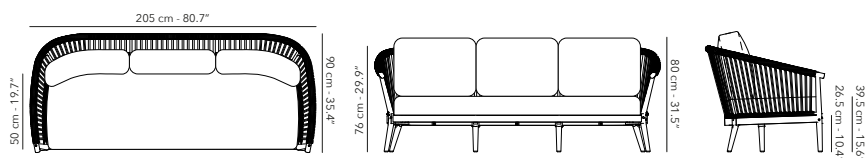

		<b>FULEG3S04</b> frame - structure		<b>W64R12</b> sable teak & cream	33.5 kg 74 lbs
	Q. DRY	<b>CULEG3S04</b> cushions - coussins - kussens		<b>C012</b> cream cat. C 	
	COMF.	<b>CULEG3S04-CF</b> cushions - coussins - kussens		<b>C012</b> cream cat. C	

Other fabrics upon request.  
Find an overview on p. 247  
Protection cover available.



# LEGNA

## CHAISE LONGUE

		<b>FULEGCL03</b> frame - structure		<b>W64R12</b> sable teak & cream	25.6 kg 56.4 lbs
	<b>Q.DRY</b>	<b>CULEGCL03</b> cushions - coussins - kussens		<b>C012</b> cream cat. C 	
	<b>COMF.</b>	<b>CULEGCL03-CF</b> cushions - coussins - kussens		<b>C012</b> cream cat. C	

Other fabrics upon request.  
Find an overview on p. 247  
Protection cover available.

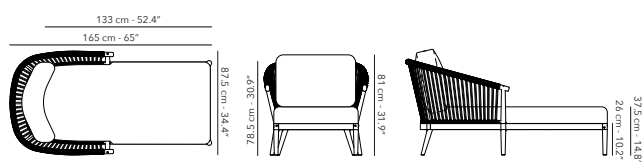

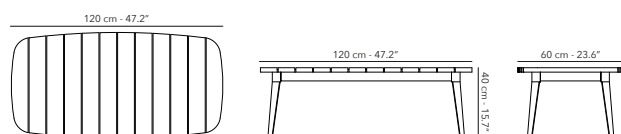

## COFFEE TABLE 120 x 60 cm

	<b>FULEGLT09</b> frame - structure		<b>W64</b> sable teak	14.2 kg 31.3 lbs
--	---------------------------------------	--	-----------------------	---------------------



## SIDE TABLE 50 x 35 cm

	<b>FULEGST07</b> frame - structure		<b>W64</b> sable teak	4.4 kg 9.7 lbs
---	---------------------------------------	---	-----------------------	-------------------

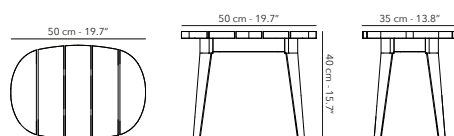







# NATURE UPDATED

Aluminium powder coated frame.  
Table top is made of raw teak with a thickness of 50 mm.  
No piece is the same, each table top is unique.  
Teak care kit available.

## BENCH 280 cm



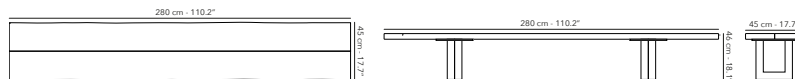

	<b>FUNATBE46S</b> frame - structure	 <b>A04 almond</b> <b>NEW</b>
		 <b>A32 black</b>
	<b>FUNATTOP46B</b> seat - siège - zitting	 <b>W62 teak</b>

 94.1 kg  
207.5 lbs

It is not possible to combine  
a Nature bench with a low dining table.



## BENCH 350 cm



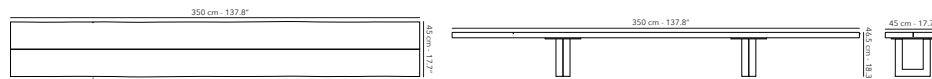

	<b>FUNATBE46S</b> frame - structure	 <b>A04 almond</b> <b>NEW</b>
		 <b>A32 black</b>
	<b>FUNATTOP48B</b> seat - siège - zitting	 <b>W62 teak</b>

 125.5 kg  
276.7 lbs

It is not possible to combine  
a Nature bench with a low dining table.



## BENCH 400 cm

	<b>FUNATBE46S</b> frame - structure	 <b>A04 almond</b> <b>NEW</b>
		 <b>A32 black</b>
	<b>FUNATTOP51B</b> seat - siège - zitting	 <b>W62 teak</b>

 139.5 kg  
307.5 lbs

It is not possible to combine  
a Nature bench with a low dining table.



# NATURE

## DINING TABLE 280 x 120 cm

	<b>FUNATDT46S</b> frame - structure	 <b>A04 almond</b> <b>NEW</b>
		 <b>A32 black</b>
	<b>FUNATTOP46</b> table top - dessus de la table - tafelblad	 <b>W62 teak</b>



171.8 kg  
378.8 lbs

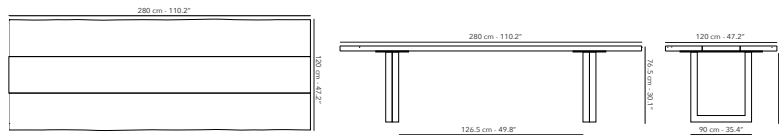

## DINING TABLE 350 x 120 cm

	<b>FUNATDT46S</b> frame - structure	 <b>A04 almond</b> <b>NEW</b>
		 <b>A32 black</b>
	<b>FUNATTOP48</b> table top - dessus de la table - tafelblad	 <b>W62 teak</b>



218 kg  
480.5 lbs

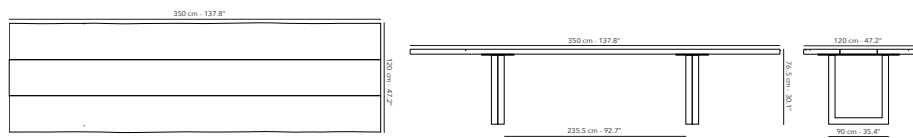

## DINING TABLE 400 x 120 cm

	<b>FUNATDT46S</b> frame - structure	 <b>A04 almond</b> <b>NEW</b>
		 <b>A32 black</b>
	<b>FUNATTOP51</b> table top - dessus de la table - tafelblad	 <b>W62 teak</b>



229.3 kg  
505.2 lbs

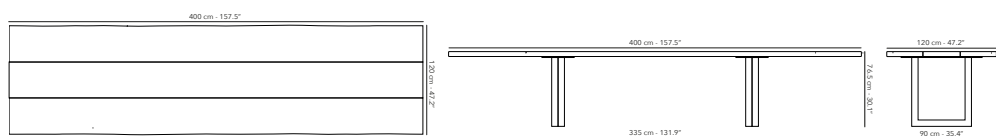



# NATURE

## LOW DINING TABLE 280 x 120 cm

	<b>FUNATLDT46S</b> frame - structure		<b>A32 black</b>
	<b>FUNATTOP46</b> table top - dessus de la table - tafelblad		<b>W62 teak</b>

## LOW DINING

 169 kg  
372.5 lbs

It is not possible to combine a Nature bench with a low dining table.

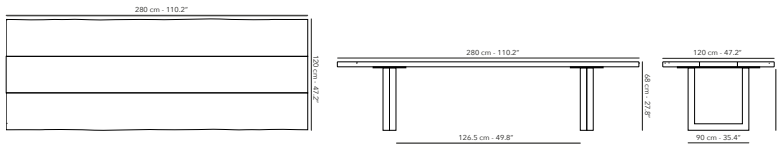

## LOW DINING TABLE 350 x 120 cm

	<b>FUNATLDT46S</b> frame - structure		<b>A32 black</b>
	<b>FUNATTOP48</b> table top - dessus de la table - tafelblad		<b>W62 teak</b>



## LOW DINING

 215.4 kg  
474.9 lbs

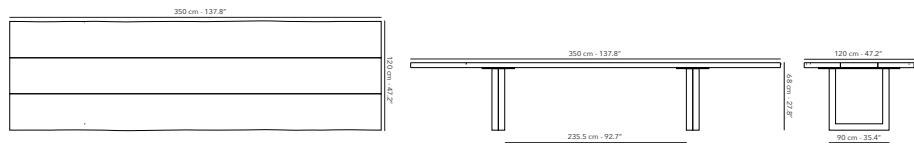
It is not possible to combine a Nature bench with a low dining table.



## LOW DINING TABLE 400 x 120 cm

	<b>FUNATLDT46S</b> frame - structure		<b>A32 black</b>
	<b>FUNATTOP51</b> table top - dessus de la table - tafelblad		<b>W62 teak</b>

## LOW DINING

 226.5 kg  
500 lbs

It is not possible to combine a Nature bench with a low dining table.

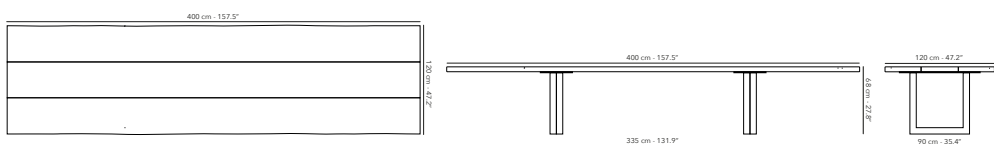





# MAUROO

## LOUNGE CHAIR 1S



**FUMAUMS02**  
frame - structure

**CUMAUMS02**  
cushions - coussins - kussens

	<b>A01</b> white
	<b>A31</b> charcoal
	<b>C006</b> vanilla cat. C
	<b>C202</b> smoke grey cat. C

10.9 kg  
17.5 lbs

Other fabrics upon request.  
Find an overview on p. 247  
Protection cover available.

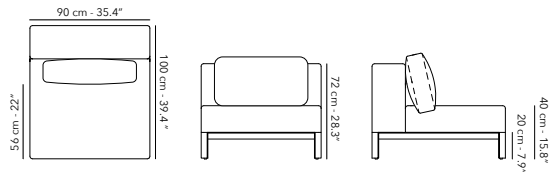

## SOFA 2S



**FUMAUDS02M**  
frame - structure

**CUMAUDS02M**  
cushions - coussins - kussens

	<b>A01</b> white
	<b>A31</b> charcoal
	<b>C006</b> vanilla cat. C
	<b>C202</b> smoke grey cat. C

24 kg  
31.7 lbs

Other fabrics upon request.  
Find an overview on p. 247  
Protection cover available.

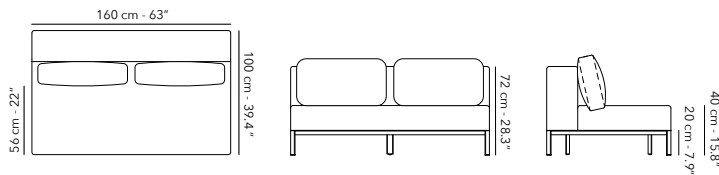

## LONG SOFA WITH TABLE



**FUMAUDS02LRF**  
frame - structure

**FUMAUTOP07**  
table top  
plateau  
tafelblad

QUICK DRY  
COMFORT

**CUMAUDS02LR**  
cushions - coussins - kussens

**CUMAUDS02LR-CF**  
cushions - coussins - kussens

	<b>A01</b> white
	<b>A31</b> charcoal
	<b>W62</b> teak
	<b>K02</b> bianco
	<b>K14</b> taupegrey
	<b>K31</b> charcoal
	<b>C006</b> vanilla cat. C
	<b>C202</b> smoke grey cat. C
	<b>C006</b> vanilla cat. C
	<b>C202</b> smoke grey cat. C







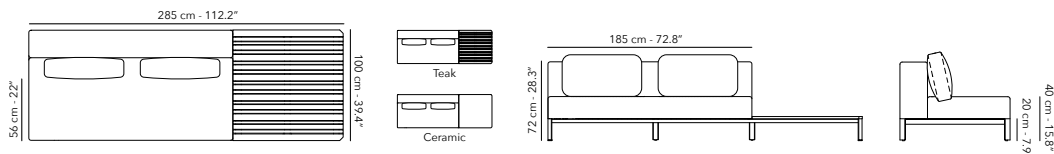







**W62**  
25 kg  
55.1 lbs





Other fabrics upon request.  
Find an overview on p. 247  
Protection cover available.



# MAUROO

## LONG SOFA WITH TABLE & ARM







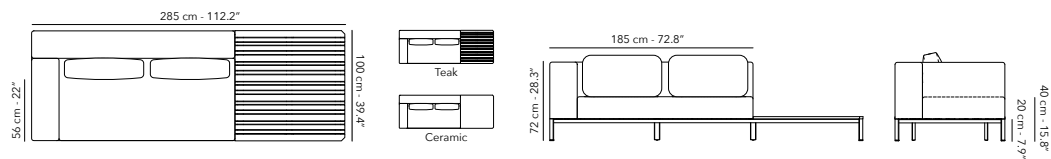





	<b>FUMAUS02LRF</b> <b>FUMAUARM01</b> frame - structure	 <b>A01</b> white
		 <b>A31</b> charcoal
	<b>FUMAUTOP07</b> table top plateau tafelblad	 <b>W62</b> teak
		 <b>K02</b> bianco
		 <b>K14</b> taupegrey
	<b>CUMAUS02LRA</b> cushions - coussins - kussens	 <b>C006</b> vanilla cat. C 
 <b>C202</b> smoke grey cat. C 		
<b>COMFORT</b> <b>CUMAUS02LRA-CF</b> cushions - coussins - kussens	 <b>C006</b> vanilla cat. C	
	 <b>C202</b> smoke grey cat. C	









**W62**  
 27 kg  
 59.5 lbs

Other fabrics upon request.  
 Find an overview on p. 247  
 Protection cover available.



## CHAISE LONGUE

	<b>FUMAUCLO2LRF</b> frame - structure	 <b>A01</b> white
		 <b>A31</b> charcoal
	<b>FUMAUTOP09</b> table top plateau tafelblad	 <b>W62</b> teak
		 <b>K02</b> bianco
		 <b>K14</b> taupegrey
	<b>COMFORT DRY</b> <b>CUMAUS02LR</b> cushions - coussins - kussens	 <b>C006</b> vanilla cat. C 
 <b>C202</b> smoke grey cat. C 		
<b>COMFORT</b> <b>CUMAUS02LR-CF</b> cushions - coussins - kussens	 <b>C006</b> vanilla cat. C	
	 <b>C202</b> smoke grey cat. C	



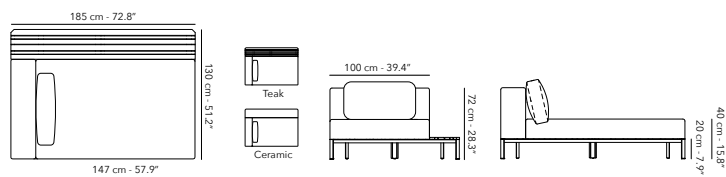

**W62**  
 23 kg  
 50.7 lbs







Other fabrics upon request.  
 Find an overview on p. 247  
 Protection cover available.





# MAUROO

## COFFEE TABLE 120 x 80 cm

	<b>FUMAULT03F</b> frame - structure	 <b>A01</b> white
		 <b>A31</b> charcoal
	<b>FUMAUTOP08</b> table top plateau tafelblad	 <b>W62</b> teak
		 <b>K02</b> bianco
		 <b>K14</b> taupegrey
		 <b>K31</b> charcoal

 **W62**  
21.5 kg  
47.4 lbs

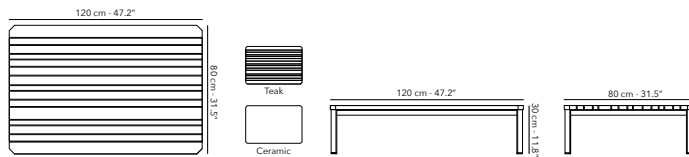





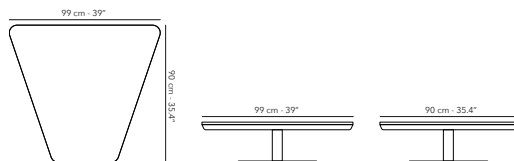







## MODULAR TABLE

	<b>FUMAUMT01</b> frame - structure	 <b>A01</b> white
		 <b>A31</b> charcoal
	<b>FUMAUTOP10</b> table top plateau tafelblad	 <b>K02</b> bianco
		 <b>K14</b> taupegrey
		 <b>K31</b> charcoal



## CONCEPT 1

LEFT / RIGHT

	frame - structure	1x FUMAUMT01 1x FUMAUDS02M 1x FUMAULT03F 1x FUMAUDS02LRF	 A01 white
			 A31 charcoal
	table top plateau tafelblad	1x FUMAUMTOP10 1x FUMAUTOP07 1x FUMAUTOP08	 W62 teak
			 K02 bianco
			 K14 taupegrey
			 K31 charcoal
COMFORT QUICK DRY	cushions - coussins - kussens	1x CUMAUDS02LR 1x CUMAUDS02M	 C006 vanilla cat. C 
			 C202 smoke grey cat. G 
COMFORT	cushions - coussins - kussens	1x CUMAUDS02LR-CF 1x CUMAUDS02M-CF	 C006 vanilla cat. C
			 C202 smoke grey cat. C





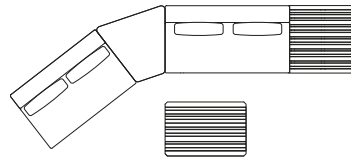
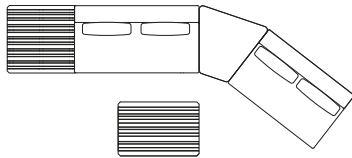









Other fabrics upon request.  
Find an overview on p. 247  
Protection cover available per module.



## CONCEPT 2

LEFT / RIGHT

	frame - structure	1x FUMAUMT01 2x FUMAUDS02M 1x FUMAULT03F 1x FUMAUDS02LRF 1x FUMAARM01	 A01 white
			 A31 charcoal
	table top plateau tafelblad	1x FUMAUMTOP10 1x FUMAUTOP07 1x FUMAUTOP08	 W62 teak
			 K02 bianco
			 K14 taupegrey
			 K31 charcoal
COMFORT QUICK DRY	cushions - coussins - kussens	1x CUMAUDS02LRA 2x CUMAUDS02M	 C006 vanilla cat. C 
			 C202 smoke grey cat. G 
COMFORT	cushions - coussins - kussens	1x CUMAUDS02LRA-CF 2x CUMAUDS02M-CF	 C006 vanilla cat. C
			 C202 smoke grey cat. C



Other fabrics upon request.  
Find an overview on p. 247  
Protection cover available per module.

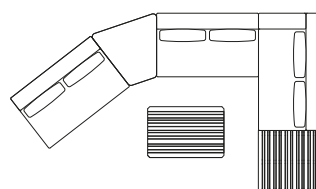
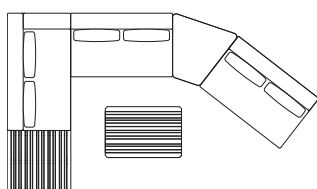





# BOLSA

## UPDATED

Filling of mixed fibre, polyester fibre & EPS beads.  
 Bottom is made of black textilene, water-repellent.  
 100% made in Belgium.

### LOUNGE CHAIR 1S 125 cm



	<b>FUBOL1S</b>	fabric of choice	
	piping passepoil bies	 <b>Y08</b> biarritz <b>NEW</b>	
		 <b>Y41</b> blade <b>NEW</b>	

14.5 kg  
31.9 lbs

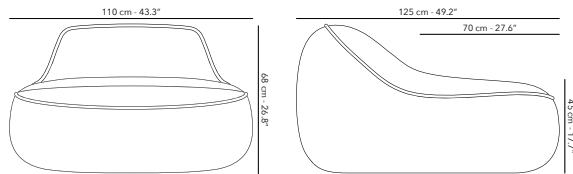
Fabric of choice.  
 Find an overview on p. 247  
 Packed in a carton box.  
 Protection cover available.



### CHAISE LONGUE 150 cm



	<b>FUBOLCL150</b>	fabric of choice	
	piping passepoil bies	 <b>Y08</b> biarritz <b>NEW</b>	
		 <b>Y41</b> blade <b>NEW</b>	

20.5 kg  
45.2 lbs

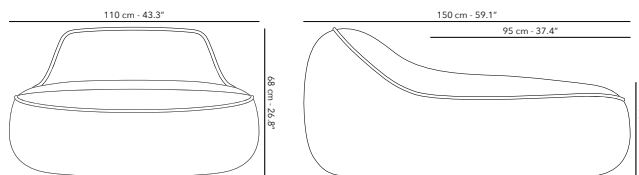
Fabric of choice.  
 Find an overview on p. 247  
 Packed in a carton box.  
 Protection cover available.



### CHAISE LONGUE 170 cm

	<b>FUBOLCL170</b>	fabric of choice	
	piping passepoil bies	 <b>Y08</b> biarritz <b>NEW</b>	
		 <b>Y41</b> blade <b>NEW</b>	

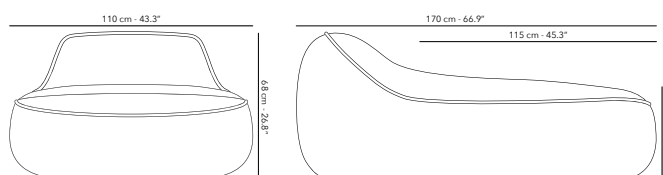

Fabric of choice.  
 Find an overview on p. 247  
 Packed in a carton box.  
 Protection cover available.



Powder coated aluminium frame with hand woven rope 3.5 mm.  
Cushions are weatherproof and colour resistant.

MANI



### DINING ARMCHAIR

	<b>FUMANAC12</b> frame - structure		<b>A04R04</b> almond & almond
	<b>CUMAN(L)AC01</b> cushion - coussin - kussen		<b>C015</b> brulé cat. D

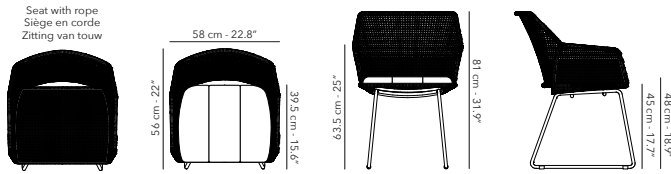
 8.4 kg  
18.5 lbs





### LOUNGE CHAIR 1S

	<b>FUMAN1S</b> frame - structure		<b>A04R04</b> almond & almond
	<b>CUMAN1S01</b> cushion - coussin - kussen		<b>C015</b> brulé cat. D

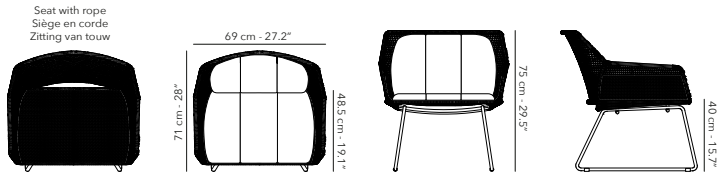
 18.4 kg  
41 lbs



### FOOTSTOOL

	<b>FUMANFS</b> frame - structure		<b>A04R04</b> almond & almond



 4.1 kg  
9 lbs





# LEWIS

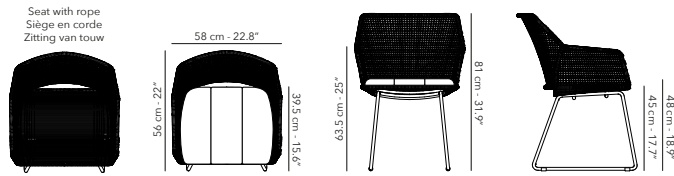

## LEWIS DINING ARMCHAIR

	<b>FULEWAC10</b> frame - structure	 <b>A32R32</b> black & black	7.5 kg 16.5 lbs
	<b>CULEW(L)AC01</b> cushion - coussin - kussen	 <b>C006</b> vanilla cat. C	



## LEWIS LOW DINING ARMCHAIR

## LOW DINING

	<b>FULEWLAC01</b> frame - structure	 <b>A32R32</b> black & black	6.6 kg 14.6 lbs
	<b>CULEW(L)AC01</b> cushion - coussin - kussen	 <b>C006</b> vanilla cat. C	

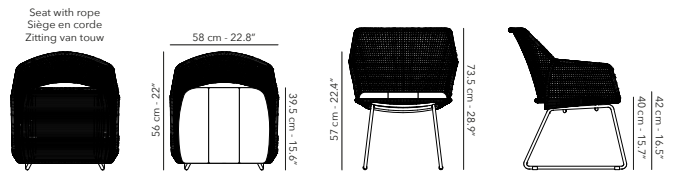

# DUNE

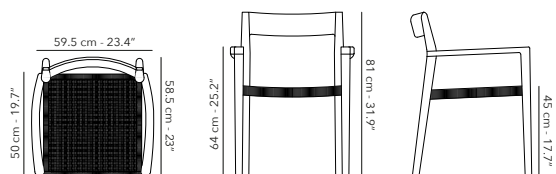

## DUNE DINING ARMCHAIR

	<p><b>FUDUNAC14</b> frame - structure</p>		<p><b>W62R03</b> teak &amp; linen</p>	<p>9.3 kg 16 lbs</p>
---	---	---	---	--------------------------



## DUNE BARCHAIR

NEW



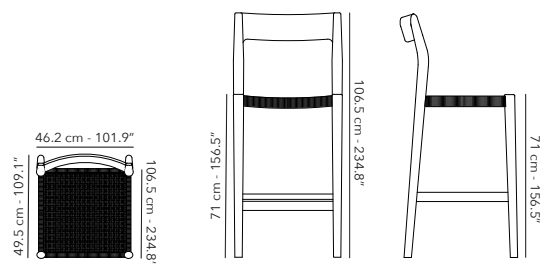



	<p><b>FUDUNBC04</b> frame - structure</p>		<p><b>W62R03</b> teak &amp; linen</p>	<p>8.6 kg 19 lbs</p>
--	---	--	---	--------------------------





# NESTING TABLES

## NESTING SIDE TABLE ø 40 cm







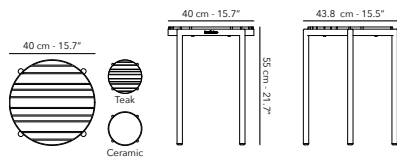

	FUVOLST02S frame	 A01 white  A31 charcoal
	FUVOLTOP00 table top	 W62 teak  K02 bianco  K14 taupegrey  K31 charcoal



**K01 - K14 - K31**    **W62**  
 5.6 kg    3.5 kg  
 12.3 lbs    7.7 lbs



## NESTING SIDE TABLE ø 50 cm





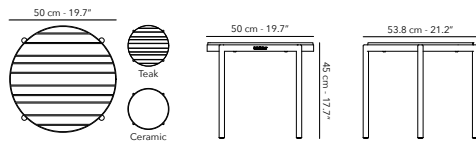

	FUVOLST03S frame	 A01 white  A14 lava  A31 charcoal
	FUVOLTOP01 table top	 W62 teak  K02 bianco  K14 taupegrey  K31 charcoal



**K01 - K14 - K31**    **W62**  
 7.6 kg    5 kg  
 16.8 lbs    11 lbs



## NESTING COFFEE TABLE ø 60 cm

	FUVOLST06S frame	 A01 white  A31 charcoal
	FUVOLTOP02 table top	 W62 teak  K02 bianco  K14 taupegrey  K31 charcoal



**K01 - K14 - K31**    **W62**  
 10.5 kg    6 kg  
 23.1 lbs    13.2 lbs

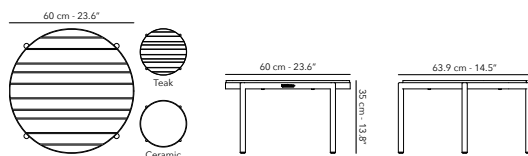

# NESTING TABLES

## NESTING COFFEE TABLE ø 75 cm



**FUVOLST04S**  
frame

**FUVOLTOP03**  
table top

	<b>A01</b> white
	<b>A14</b> lava
	<b>A31</b> charcoal
	<b>W62</b> teak
	<b>K02</b> bianco
	<b>K14</b> taupegrey
	<b>K31</b> charcoal



**K01 - K14 - K31**      **W62**  
14.8 kg                      8 kg  
32.6 lbs                    17.6 lbs

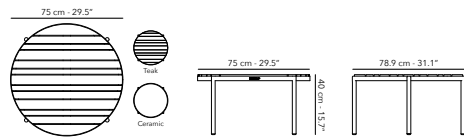

## NESTING COFFEE TABLE ø 90 cm



**FUVOLST05S**  
frame

**FUVOLTOP04**  
table top

	<b>A01</b> white
	<b>A14</b> lava
	<b>A31</b> charcoal
	<b>W62</b> teak
	<b>K02</b> bianco
	<b>K14</b> taupegrey
	<b>K31</b> charcoal



**K01 - K14 - K31**      **W62**  
20.5 kg                      10 kg  
45.2 lbs                    22 lbs

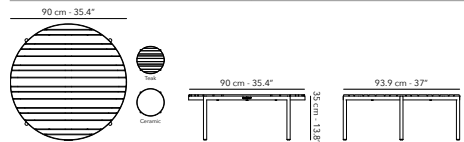



# NESTING TABLES



## TARO COFFEE TABLE ROUND $\varnothing$ 90 cm

	<b>FUTARLT13</b> frame - structure		<b>A03</b> linen
---	---------------------------------------	---	------------------

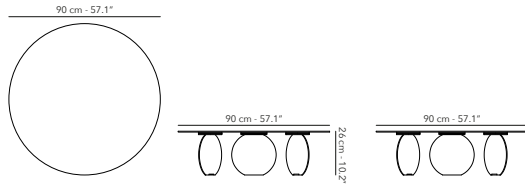
12.5 kg  
27.6 lbs





## TARO COFFEE TABLE ORGANIC 145 x 100 cm

	<b>FUTARLT14</b> frame - structure		<b>A03</b> linen
--	---------------------------------------	---	------------------

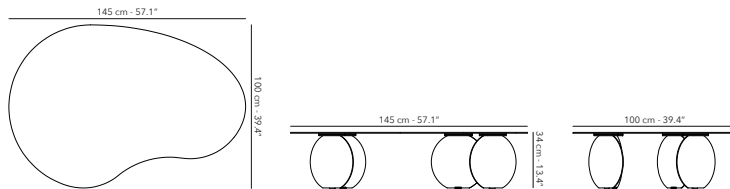
20 kg  
44.1 lbs



## KOBE SIDE TABLE $\varnothing$ 40 cm

	<b>FUKOBST11</b> Kobe side table small		<b>W62</b> teak
---	---	---	-----------------

19.1 kg  
42.1 lbs

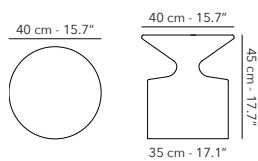

# NESTING TABLES

## KOBE SIDE TABLE ø 50 cm



**FUKOBST12**  
Kobe side table large



**W62** teak

38.3 kg  
84.4 lbs

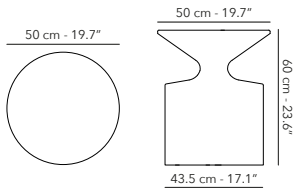

## DUNCAN



**DEDUN.S-W62**  
teak block



**W62** teak

27.4 kg  
60.4 lbs

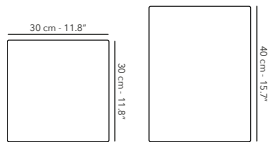

## DUNCAN 70 x 30 x 30 cm

**NEW**



**DEDUN.M-W62**  
Duncan teak block



**W62** teak

31 kg  
68.3 lbs

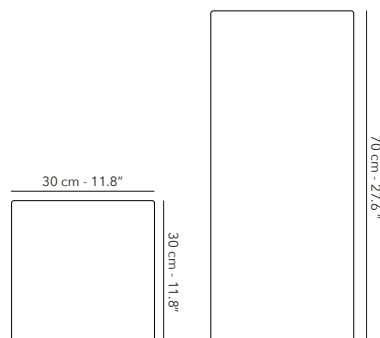



# POTTERY













## UPDATED

Each pot is handmade with natural materials, combined with FRP.  
A robust, yet lightweight pot, UV and frost resistant.













### TERRA CLASSIC

	<b>DEPOTTERC48.L</b> 6 kg, 13.2 lbs ø 48 x 57 cm, 19 x 22.5"		P03 sabbia
			P11 macchiato
			P32 nero
	<b>DEPOTTERC60.M</b> 9 kg, 19.8 lbs ø 60 x 72 cm, 23.6 x 28.3"		P03 sabbia
			P11 macchiato
			P32 nero
	<b>DEPOTTERC150.H</b> 70 kg, 154.3 lbs ø 150 x 180 cm, 59 x 71"		P11 macchiato

### TERRA BALLOON





	<b>DEPOTTERB55.L</b> 5 kg, 11 lbs ø 55 x 35 cm, 22 x 14"		P03 sabbia
			P11 macchiato
			P32 nero
	<b>DEPOTTERB55.M</b> 5.5 kg, 12.1 lbs ø 55 x 45 cm, 22 x 18"		P03 sabbia
			P11 macchiato
			P32 nero
	<b>DEPOTTERB55.H</b> 6 kg, 13.2 lbs ø 55 x 56 cm, 22 x 22"		P03 sabbia
			P11 macchiato
			P32 nero

### TERRA CERCHIO

	<b>DEPOTTERB-SET1:</b> 31 kg, 68.3 lbs DEPOTTERB91.H DEPOTTERB112.H		P03 sabbia
			P11 macchiato
			P32 nero
	<b>DEPOTTERB91.H</b> 12 kg, 26.5 lbs ø 91 x 56 cm, 36 x 22"		P03 sabbia
			P11 macchiato
			P32 nero
	<b>DEPOTTERB112.H</b> 19 kg, 41.9 lbs ø 112 x 67 cm, 44 x 26"		P03 sabbia
			P11 macchiato
			P32 nero

# POTTERY

## TERRA DÔME SET

	<b>DEPOTTERD-SET1</b> 32 kg, 70.5 lbs ø 45 x 45 cm, 17.7 x 17.7" ø 61 x 61 cm, 24 x 24" ø 83 x 82 cm, 32.6 x 32.3"		P03 sabbia
			P11 macchiato
			P32 nero

## TERRA ALTO

	<b>DEPOTERR45.M</b> ø 45 x 112 cm, 18 x 44"		P03 sabbia
			P11 macchiato
			P32 nero
	<b>DEPOTERR55.H</b> ø 55 x 137 cm, 22 x 54"		P03 sabbia
			P11 macchiato
			P32 nero

## CUMINO ALBERO

	<b>DEPOTCUM-SET1:</b> DEPOTCUM52.L DEPOTCUM68.M DEPOTCUM88.H		P18 ruggine
	<b>DEPOTCUM52.L</b> ø 52 x 60 cm, 20 x 24"		P18 ruggine
	<b>DEPOTCUM68.M</b> ø 68 x 80 cm, 27 x 31"		P18 ruggine
	<b>DEPOTCUM88.H</b> ø 88 x 102 cm, 35 x 40"		P18 ruggine



## TERRA CERCHIO SET 2

NEW



	<b>DEPOTTERB-SET2</b> ø 55 x 35 cm ø 73 x 46 cm ø 91 x 56 cm		P04 pietra
---	---	---	------------

# POTTERY



## CUMINO FIORE

	<p><b>DEPOTCUM-SET2</b>          ø 55 x 46 cm, 21.6 x 18"          ø 65 x 54 cm, 25.5 x 21.2"          ø 80 x 66 cm, 31.5 x 26"</p>		<p><b>P18</b> ruggine</p>
---	---	---	---------------------------

## CUMINO FUNGO

	<p><b>DEPOTCUM114.L</b>          ø 114 x 54 cm, 56,7 x 21"</p>		<p><b>P01</b> panna</p>
---	--	---	-------------------------

## CUMINO CONICO

	<p><b>DEPOTCUM-SET3:</b>  <b>DEPOTCUM46.L</b>          4 kg, 8.8 lbs          ø 46 x 46 cm, 18.1 x 18.1"</p>		<p><b>P01</b> panna</p>
	<p><b>DEPOTCUM61.M</b>          9 kg, 19.8 lbs          ø 61 x 61,5 cm, 24 x 24.2"  <b>DEPOTCUM84.H</b>          15 kg, 33.1 lbs          ø 84 x 82 cm, 33.1 x 32.3"</p>		<p><b>P18</b> ruggine</p>

## CURVO

	<p><b>DEPOTCUR-SET1:</b>          DEPOTCUR32.L          DEPOTCUR45.M          DEPOTCUR55.H</p>		<p><b>P04</b> pietra <b>NEW</b></p>
			<p><b>P30</b> caffè</p>
	<p><b>DEPOTCUR32.L</b>          ø 32 x 60 cm, 13 x 24"</p>		<p><b>P30</b> caffè</p>
	<p><b>DEPOTCUR45.M</b>          ø 45 x 80 cm, 18 x 31"</p>		<p><b>P30</b> caffè</p>
	<p><b>DEPOTCUR55.H</b>          ø 55 x 90 cm, 22 x 35"</p>		<p><b>P30</b> caffè</p>







# POTTERY



## CUMINO CALICE

	<b>DEPOTCUMB120.H</b> ø 120 x 130 cm, 47 x 51"		<b>P01</b> panna
---	---	---	------------------



## CARTELLO

	<b>DEPOTCAR75.L</b> ø 75 x 35 cm, 30 x 14"		<b>P31</b> marone
	<b>DEPOTCAR75.H</b> ø 75 x 68 cm, 30 x 27"		<b>P31</b> marone







## ANTICO ANFORA

	<b>DEPOTANT55.L</b> 5.5 kg, 12.1 lbs ø 55 x 55 cm, 21.7 x 21.7"		<b>P07</b> pistachio
			<b>P12</b> bronzo

## ANTICO VASO



	<b>DEPOTANT55.H</b> 14 kg, 30.9 lbs ø 55 x 112 cm, 21.7 x 44"		<b>P07</b> pistachio
			<b>P12</b> bronzo

## TUGU

	<b>DEPOTTUG45.S</b> 3.8 kg, 8.4 lbs ø 45 x 35 cm, 17 x 14"		<b>F16</b> cottage
	<b>DEPOTTUG65.M</b> 7.3 kg, 16.1 lbs ø 65 x 50 cm, 26 x 20"		<b>F16</b> cottage
	<b>DEPOTTUG85.L</b> 11.5 kg, 25.4 lbs ø 85 x 70 cm, 33 x 28"		<b>F16</b> cottage

# POTTERY

## CUMINO ALBERO HIGH $\varnothing$ 88 x 102 cm

	<p><b>DEPOTCUM88.H</b> Cumino Albero High</p>		<p><b>P18</b> ruggine</p>
---	---	---	---------------------------

## CUMINO ALBERO SET 5 set of 3

NEW

	<p><b>DEPOTCUM-SET5</b> <math>\varnothing</math> 40 x 47 cm <math>\varnothing</math> 52 x 61 cm <math>\varnothing</math> 68 x 80 cm</p>		<p><b>P04</b> pietra</p>
---	---	---	--------------------------

## CUMINO FIORE SET 4 set of 3

NEW

	<p><b>DEPOTCUM-SET4</b> <math>\varnothing</math> 36 x 31 cm <math>\varnothing</math> 45 x 38 cm <math>\varnothing</math> 55 x 46 cm</p>		<p><b>P04</b> pietra</p>
--	---	---	--------------------------

## CUBO SQUARE SMALL SET 1 set of 2

NEW

	<p><b>DEPOTCUB-SET1</b> 50 x 50 x 50 cm 60 x 60 x 60 cm</p>		<p><b>P01</b> panna</p>
			<p><b>P33</b> ombra</p>

## CUBO SQUARE LARGE SET 2 set of 2

NEW

	<p><b>DEPOTCUB-SET2</b> 75 x 75 x 75 cm 90 x 90 x 90 cm</p>		<p><b>P01</b> panna</p>
			<p><b>P33</b> ombra</p>

# POTTERY

## CUBO DIVIDER SMALL 90 x 45 x 90 cm

NEW



DEPOTCUB-DIV-S  
Cubo divider small



P01 panna



P33 ombra

## CUBO DIVIDER LARGE 150 x 45 x 90 cm

NEW



DEPOTCUB-DIV-L  
Cubo divider large



P01 panna



P33 ombra









# RUGS

## WILSON

	<b>DERUGWIL200X300</b> 200 x 300 cm, 79 x 118"		D78 oyster
			D79 greige
	<b>DERUGWIL250X350</b> 250 x 350 cm, 98 x 138"		D78 oyster
			D79 greige
	<b>DERUGWIL280X390</b> 280 x 390 cm, 110 x 154"		D78 oyster
			D79 greige





Polyester and high-quality Decolan yarn.  
Made in Belgium.

## COCO

	<b>DERUGCOC300XR</b> ø 300 cm, 118"		D72 camel
	<b>DERUGCOC300X400</b> 300 x 400 cm, 118 x 157"		D72 camel
	<b>DERUGCOC400X600</b> 400 x 600 cm, 157 x 236"		D72 camel

Hand braided polyolefin rope.

## IONA

	<b>DERUGION300XR</b> ø 300 cm, 118"		D05 seal
	<b>DERUGION300X400</b> 300 x 400 cm, 118 x 157"		D05 seal
	<b>DERUGION400X500</b> 400 x 500 cm, 157 x 197"		D05 seal
	<b>TAILORMADE</b> Maximum width 3m, unlimited length possible		D05 seal

PVC coated polyester.

## YARA

	<b>DERUGYAR300XR</b> ø 300 cm, 118"		D71 biscuit
	<b>DERUGYAR250X350</b> 250 x 350 cm, 98 x 138"		D71 biscuit
	<b>DERUGYAR300X400</b> 300 x 400 cm, 118 x 157"		D71 biscuit
	<b>TAILORMADE</b> Maximum width 3m, unlimited length possible		D71 biscuit

PVC coated polyester.



## NINO

	<b>DERUGNIN300XR</b> ø 300 cm, 118"		D76 beaver
	<b>DERUGNIN250X350</b> 250 x 350 cm, 98 x 138"		D76 beaver
	<b>DERUGNIN300X400</b> 300 x 400 cm, 118 x 157"		D76 beaver
	<b>TAILORMADE</b> Maximum width 3m, unlimited length possible		D76 beaver

PVC coated polyester.



# POUFS

## BAY small

		<b>DEPOUBAY.RS</b>	small - ø 50 x 40 cm, 19 x 16"	
	OPTIONAL	piping		<b>Y08 biarritz NEW</b>
				<b>Y41 blade NEW</b>



Fabric of choice.  
Find an overview on p. 247

## BAY medium

		<b>DEPOUBAY.RM</b>	medium - ø 50 x 50 cm, 19 x 19"	
	OPTIONAL	piping		<b>Y08 biarritz NEW</b>
				<b>Y41 blade NEW</b>





Fabric of choice.  
Find an overview on p. 247

## BAY large

		<b>DEPOUBAY.RL</b>	large - ø 80 x 40 cm, 32 x 16"	
	OPTIONAL	piping		<b>Y08 biarritz NEW</b>
				<b>Y41 blade NEW</b>

Fabric of choice.  
Find an overview on p. 247













## COCO

	<b>DEPOUCOC.RS</b> round small ø 50 x 40 cm, 19 x 16"		<b>D72 camel</b>
	<b>DEPOUCOC.RM</b> round medium ø 50 x 50 cm, 19 x 19"		<b>D72 camel</b>
	<b>DEPOUCOC.RL</b> round large ø 80 x 40 cm, 32 x 16"		<b>D72 camel</b>
	<b>DEPOUCOC.SS</b> square small 50 x 40 cm, 20 x 16"		<b>D72 camel</b>
	<b>DEPOUCOC.SL</b> square large 100 x 40 cm, 39 x 16"		<b>D72 camel</b>

Hand braided polyolefin rope.

# LIGHTING

## SOLORE Solar Hybrid module incl.

	<b>DELIGSOL.CS</b> Cube small 25 x 25 cm, 10 x 10"	 F15 natural  F17 taupe
	<b>DELIGSOL.CM</b> Cube medium 33,5 x 33,5 cm, 13 x 13"	 F15 natural  F17 taupe
	<b>DELIGSOL.CL</b> Cube large 43 x 43 cm, 17 x 17"	 F15 natural  F17 taupe
	<b>DELIGSOL.SS</b> Sphere small ø 30 x 24,5 cm, 12 x 10"	 F15 natural  F17 taupe
	<b>DELIGSOL.SM</b> Sphere medium ø 38,5 x 33,5 cm, 15 x 13"	 F15 natural  F17 taupe
	<b>DELIGSOL.SL</b> Sphere large ø 47,5 x 43 cm, 19 x 17"	 F15 natural  F17 taupe

Solar-powered LED lamp for warm outdoor light.  
 Rechargeable battery with solar energy or USB.  
 Can be placed on the ground or hung up.  
 Supplied with rope and USB cable.  
 Control the light with the application "SLS Control".  
 Available in the App Store and Google Play.  
 The Solore Solar Module is included.



Aluminium structure enclosed in HDPE fibre.

## NOTO OVAL

	<b>DELIGNOT.S</b> oval small ø 39 x 48.5 cm, 15 x 19"	 A31R32 charcoal & black  A31R06 charcoal & natural
	<b>DELIGNOT.L</b> oval large ø 48 x 60 cm, 19 x 24"	 A31R32 charcoal & black  A31R06 charcoal & natural



Rechargeable battery with solar energy or USB.  
 Hand woven rope with solar lamp.

## NOTO CONIC

	<b>DELIGNOT.CS</b> conic small	 A31R06 charcoal & natural
	<b>DELIGNOT.CL</b> conic large	 A31R06 charcoal & natural

Rechargeable battery with solar energy or USB.  
 Hand woven rope with solar lamp.

## ARCO



	<b>DELIGARC.S</b> small ø 39 x 48.5 cm, 15 x 19"	 F18 straw
	<b>DELIGARC.L</b> large ø 48 x 60 cm, 19 x 24"	 F18 straw

Rechargeable battery with solar energy or USB.  
 Synthetic material with solar lamp.





# ACCESSORIES

## ANTIBES WINE

	<b>DEDECANT-TUB.01</b> winetub ø 50 x 22.5 cm, 19.7 x 9"		<b>W62</b> teak
	<b>DEDECANT-COOL.01</b> winecooler ø30 x 30 cm, 12 x 12"		<b>W62</b> teak

Teak with stainless steel parts.

## PRANA

	<b>DEBASPRAS</b> small ø 45 x 40 cm, 17.2 x 15.7"		<b>D05</b> seal
	<b>DEBASPRAL</b> large ø 65 x 58 cm, 25.6 x 22.8"		<b>D05</b> seal

PVC coated polyester.

## DECO CUSHION

	<b>CUDECO40X40</b> 40 x 40 cm
	<b>CUDECO50X30</b> 50 x 30 cm
	<b>CUDECO50X50</b> 50 x 50 cm

Fabric of choice.  
Find an overview on p. 247

# UMBRELLAS OVERVIEW

## MID POLE ALUMINIUM



**JCP.1 Series**  
Technical p. 144



**JCP.2 Series**  
Technical p. 145



**Tuli**  
Technical p. 164



**Amalfi**  
Technical p. 166

## MID POLE WOOD



**Macramé**  
Technical p. 168



**Cuba**  
Technical p. 170



**Moorea**  
Technical p. 172

# UMBRELLAS OVERVIEW

## FREE POLE ALUMINIUM



**JCP.3 Series**  
Technical p. 148



**JCP.4 Series**  
Technical p. 151



**JCP.5 Series**  
Technical p. 156



**JCP.6 Series**  
Technical p. 157

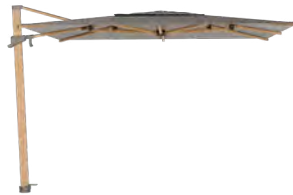

**Azore**  
Technical p. 158



**Antego**  
Technical p. 160



**Lima**  
Technical p. 162



# FURNITURE OVERVIEW

## DINING CHAIRS



**Tondo**  
Technical p. 182



**Noa**  
Technical p. 188



**Noa**  
Technical p. 188



**Legna**  
Technical p. 198



**Mani**  
Technical p. 211



**Lewis / Lewis low**  
Technical p. 212



**Dune**  
Technical p. 213

# FURNITURE OVERVIEW

## BENCHES



**Nature**  
Technical p. 202

## BAR & COUNTER



**Noa bar**  
Technical p. 188



**Dune bar**  
Technical p. 213

# FURNITURE OVERVIEW

## DINING TABLES



**Como**  
Technical p. 186



**Como**  
Technical p. 186



**Noa**  
Technical p. 189



**Legna**  
Technical p. 199



**Nature**  
Technical p. 203



**Nature low**  
Technical p. 204



# FURNITURE OVERVIEW

## LOUNGE CHAIRS



**Tatami**  
Technical p. 180



**Tatami**  
Technical p. 180



**Tondo**  
Technical p. 182



**Noa**  
Technical p. 190



**Tugu**  
Technical p. 194



**Legna**  
Technical p. 200



**Mauro**  
Technical p. 206



**Bolsa**  
Technical p. 210



**Mani**  
Technical p. 211

# FURNITURE OVERVIEW

## SOFAS



**Tatami**  
Technical p. 180



**Tatami**  
Technical p. 181



**Tondo**  
Technical p. 182



**Tondo**  
Technical p. 183



**Tondo**  
Technical p. 183



**Noa**  
Technical p. 190



**Noa**  
Technical p. 190



**Noa**  
Technical p. 192



**Tugu**  
Technical p. 194



**Tugu**  
Technical p. 194



**Tugu**  
Technical p. 195



**Legna**  
Technical p. 200



**Legna**  
Technical p. 200



**Mauroo**  
Technical p. 206



**Mauroo**  
Technical p. 206



**Mauroo**  
Technical p. 207

# FURNITURE OVERVIEW

## SUNLOUNGERS



**Noa**  
Technical p. 193



**Noa**  
Technical p. 192



**Tugu**  
Technical p. 196



**Legna**  
Technical p. 201



**Mauroo**  
Technical p. 207



**Bolsa**  
Technical p. 210



# FURNITURE OVERVIEW

## DAYBEDS



**Tondo**  
Technical p. 181



**Tondo**  
Technical p. 185



**Tugu**  
Technical p. 196

## LOW TABLES



**Tondo**  
Technical p. 184



**Tondo**  
Technical p. 184



**Como**  
Technical p. 186



**Como**  
Technical p. 187



**Como**  
Technical p. 187



**Como**  
Technical p. 187



**Noa**  
Technical p. 191



**Noa**  
Technical p. 191



**Noa**  
Technical p. 191



**Tugu**  
Technical p. 195



**Tugu**  
Technical p. 195



**Tugu**  
Technical p. 196

# FURNITURE OVERVIEW



**Legna**  
Technical p. 201



**Legna**  
Technical p. 201



**Mauroo**  
Technical p. 204



**Mauroo**  
Technical p. 204



**Nesting tables**  
Technical p. 214



**Nesting tables**  
Technical p. 214



**Duncan**  
Technical p. 217



**Duncan**  
Technical p. 217



**Kobe**  
Technical p. 216



**Kobe**  
Technical p. 217



**Taro**  
Technical p. 216



**Taro**  
Technical p. 216

# MAINTENANCE & PROTECTION

## PROTECTION COVER

	UPJCP.1S-X77	JCP.1 Series
	UPJCP.202-X77	JCP. 202
	UPJCP.2S-X77	JCP.201 & JCP.203
	UPJCP.3S-X77	JCP.3 Series
	UPJCP.4S-X77	JCP.4 Series
	UPJCP.5S-X77	JCP.5 Series
	UPJCP.6S-X77	JCP.6 Series
	UPAZO-M-X75	Azore
	UPANT-M-X75	Antego
	UPKIN-L-X75	Lima
	UPUMB-S-X75	Tuli & Malibu
	UPAMA-M-X75	Amalfi
	UPCUB-M	Cuba & Moorea
	FP... X75	Furniture collection

To enhance the durability and appearance, we recommend following our care instructions regularly.

The umbrella should never be used in strong wind or rainy conditions. An open umbrella should never be left unattended. We always suggest storing your furniture and outdoor umbrella in a dry place when not in use or using a protective cover to avoid any blurring or damage.

## FABRICS

	<b>SPCARE-TEXT-75CL</b> fabrics	2 sponges, 3 application cloths 1 textile protector 750ml 1 textile cleaner 750ml
---	------------------------------------	---





## STONE

	<b>SPCARE-STONE-50CL</b> natural stone	1 sponge, 1 applicaton cloth 1 natural stone protector 500ml 1 natural stone cleaner 500ml
---	---	--

























# MAINTENANCE & PROTECTION

## TEAK

	<p><b>FUCARECL-W62-1L</b> <b>FUCAREPR-W62-1L</b> natural teak care kit</p> <p>Suitable for Noa, Nature, Tecca and Flexx collection &amp; Dune dining chair</p> 	<p>teak cleaner 1000ml teak protector 1000ml</p>
	<p><b>FUCARE-W64-75CL</b> sable teak care kit</p> <p>Suitable for Legna collection</p> 	<p>exterior oil 750ml exterior cleaner 250ml scouring sponge gloves &amp; brush cloth red polishing pad &amp; holder</p>
	<p><b>FUCARE-W68-75CL</b> black teak care kit</p> <p>Suitable for Nero collection</p> 	<p>exterior oil 750ml exterior cleaner 250ml scouring sponge gloves &amp; brush cloth red polishing pad &amp; holder</p>

## CORRECTOR PEN 12 ML

	<p><b>SPCOR-12ML</b></p>	<table border="1"> <tr> <td></td> <td><b>A01</b> white</td> </tr> <tr> <td></td> <td><b>A03</b> linen</td> </tr> <tr> <td></td> <td><b>A11</b> taupe</td> </tr> <tr> <td></td> <td><b>A14</b> lava</td> </tr> <tr> <td></td> <td><b>A30</b> anthracite</td> </tr> <tr> <td></td> <td><b>A31</b> charcoal</td> </tr> <tr> <td></td> <td><b>A32</b> black</td> </tr> </table>		<b>A01</b> white		<b>A03</b> linen		<b>A11</b> taupe		<b>A14</b> lava		<b>A30</b> anthracite		<b>A31</b> charcoal		<b>A32</b> black
	<b>A01</b> white															
	<b>A03</b> linen															
	<b>A11</b> taupe															
	<b>A14</b> lava															
	<b>A30</b> anthracite															
	<b>A31</b> charcoal															
	<b>A32</b> black															

Quick-drying liquid paint with built-in brush for powder-coated surfaces. Ideal for retouching small surface traces (scratches, wear).

## UMBRELLA ACCESSORIES



### LUNA LED LIGHT

UALUN-LED02

You create a warm glow by adding this outdoor umbrella light to the built-in holder on the frame. Luna LED light is wireless with 16 LEDs and gives a warm colour. Using the BT speaker, the module will play music for six to ten hours.

**Colour:** grey

**Light:** LED warm light

**Fits on:** Azore - Antego - Lima - Amalfi - Malibu

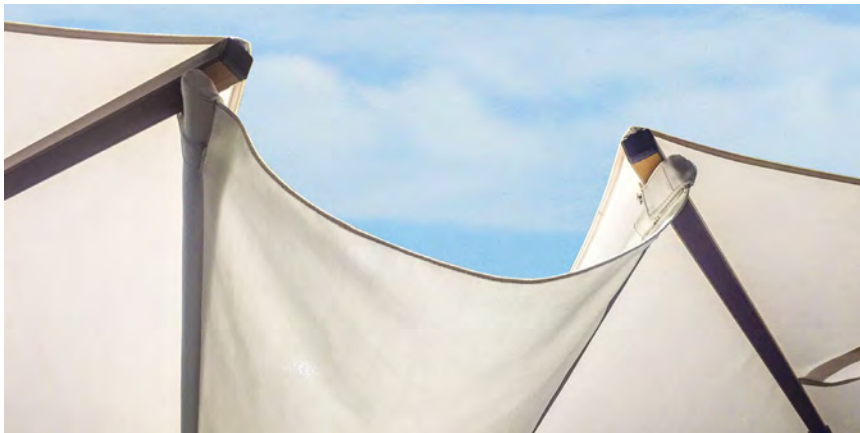

### GUTTERS

Gutters offer an uninterrupted protection between several umbrellas. By connecting the parasols, large areas have a complete coverage against the sun or rainy weather. A gutter is always attached to the parasol with a slight slope in order to drain the water efficiently in the desired directions.

Our gutters are available in the same colour as the cloth of the parasol to match perfectly. Only applicable on the following parasols: JCP.201, JCP.202 and JCP.501.

## UMBRELLAS

### CATEGORY 3

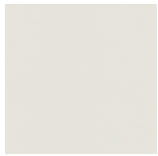

C003 pearl

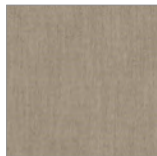

C011 cotton

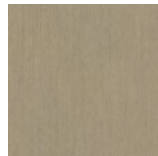

C022 nile



C025 mushroom

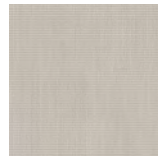

C026 howlite



C027 moonstone



C028 flax



C029 wheat

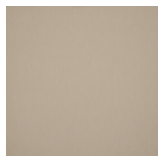

C030 papyrus



C031 nutmeg

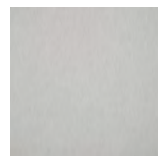

C100 ice



C107 mooncrest



C114 concrete



C115 cadet

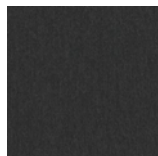

C207 onyx

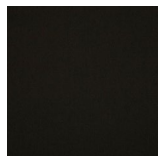

C210 pitch



C216 rock



C217 iron



C218 pewter

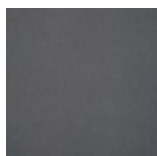

C219 titanium



C220 basalt

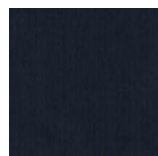

C221 faroe



C222 slate

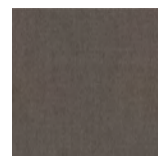

C305 umber

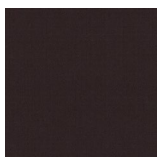

C308 gravel

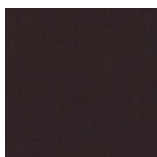

C309 ebène



C452 sunset

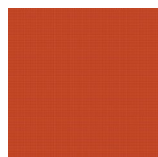

C453 rotala

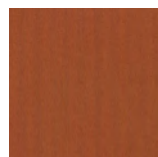

C454 gobi



C455 burgundy



C456 crimson



C457 sunrise

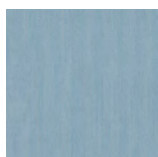

C458 fjord



C459 lapis



C460 celestial



C461 marine



# MATERIALS



C462 teal



C463 navy

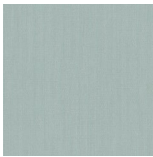

C464 glacier

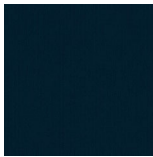

C465 loyal

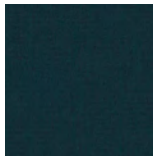

C466 emerald

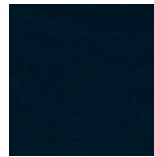

C468 berry

## CATEGORY 2



C019 tofu

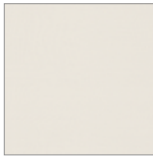

C020 powder

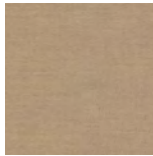

C023 heather

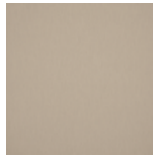

C032 tulle

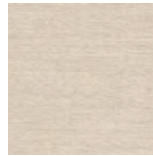

C033 lin



C034 antique

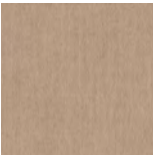

C035 trush



C036 fawn



C112 fog

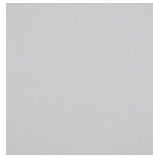

C113 plaster

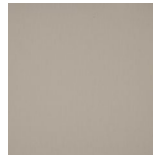

C116 cobble

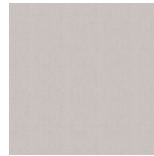

C117 milk



C118 steam

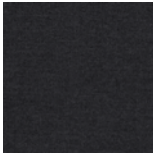

C214 eclipse



C215 shadow



C223 fuel

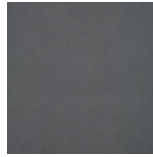

C224 lead



C225 ardoise

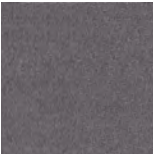

C226 tweed



C227 blackboard



C307 cacao



C310 amber



C311 vino



C312 chestnut

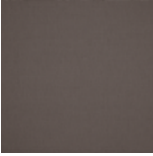

C313 auburn



C314 chocolate

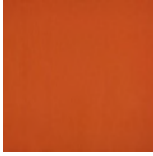

C402 tangerine

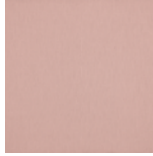

C403 pink

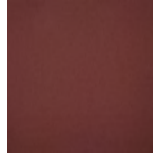

C409 brick

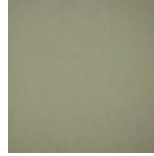

C443 moss

# MATERIALS



C444 peach



C450 arctic



C451 belharra

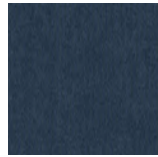

C469 mistral

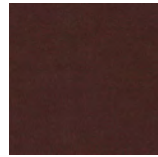

C470 merlot



C471 antelope



C472 hive



C473 poppy



C474 pepper



C475 vivid



C476 calathea

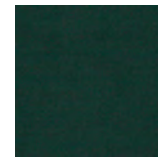

C477 pinea



C478 macao

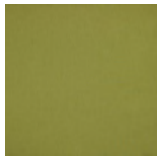

C479 lichen

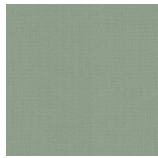

C480 seafoam

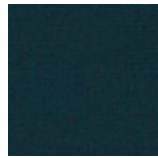

C481 beryl



C482 adriatic



C483 trust



C484 cyan



C485 curacao



C486 crisp

## CATEGORY 1



C001 natural

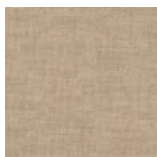

C010 latte

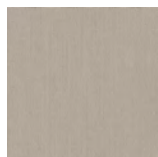

C024 clay

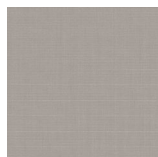

C101 cloud



C208 black



C211 steel



C208 black

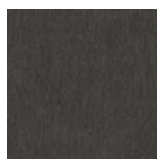

C211 steel



C304 walnut

# MATERIALS

## TECHNICAL INFORMATION

	CATEGORY 3	CATEGORY 2	CATEGORY 1
<b>COMPOSITION</b>	100% solution dyed acrylic	100% solution dyed acrylic	100% solution dyed polyester
<b>GRAMMAGE</b>	320 g/m <sup>2</sup>	260 g/m <sup>2</sup>	270 g/m <sup>2</sup>
<b>LIGHTFASTNESS</b>	level 7-8	level 7-8	level 6-7
<b>WATER RESISTANCE</b>	1000 mm	400 mm	100 mm
<b>UV PROTECTION</b>	> 98%	> 98%	> 98%

More technical details about our fabrics can be found on [www.jardinico.com](http://www.jardinico.com).



# MATERIALS

## CARACTÈRE COLLECTION

### ALUMINIUM frame

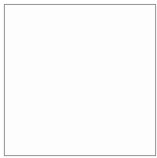

A01 white

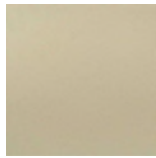

A03 linen



A10 cappuccino



A12 alu teak

Powdercoated aluminium.

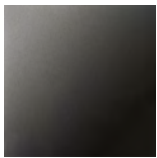

A31 charcoal



A32 black

### STEEL Caractère collection umbrella base

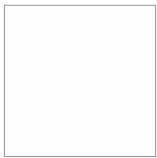

S01 white

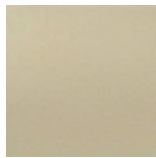

S03 linen

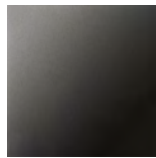

S31 charcoal



S32 black

Hot galvanised powder coated steel plates, heavy and rust free.

## ATTITUDE COLLECTION

### ALUMINIUM frame

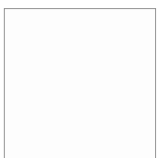

A01 white

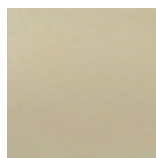

A03 linen

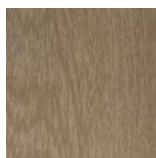

A08 matt oak



A12 alu teak

Powdercoated aluminium.



A14 lava

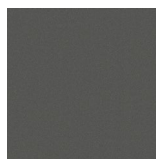

A30 anthracite



A32 black

# MATERIALS

## NATURAL STONE umbrella base



G04 light grey granite



G13 Egyptian sandstone



G32 black granite

Extremely strong and low porous. Stain repellent, UV-resistant, and resistant to heat, frost and mold. Due to its natural composition, variations in colour and pattern are inherent to each stone.

## NATURAL STONE umbrella base

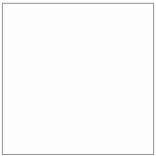

S01 white



S03 linen

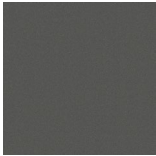

S30 anthracite

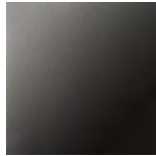

S31 charcoal

Hot galvanised powder coated steel plates, heavy and rust free.



S32 black

## CONCRETE umbrella base

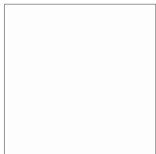

B01 white

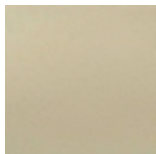

B03 linen



B06 hazel

Robust and long-lasting, resistant to frost and heat.

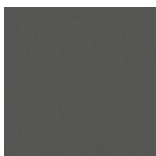

B30 anthracite



B32 black

## FURNITURE



**C006 vanilla**  
cat. C



**C008 linen**  
cat. B

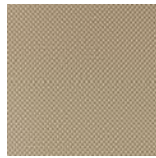

**C012 cream**  
cat. C



**C015 brulé**  
cat. D



**C016 pampas**  
cat. C



**C018 sienna**  
cat. C



**C111 truffle**  
cat. D

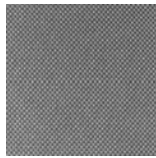

**C202 smoke grey**  
cat. C

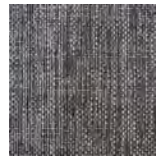

**C306 toast**  
cat. C



**C419 lime**  
cat. D

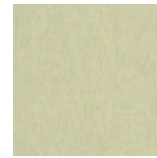

**C420 mint**  
cat. B



**C422 sage**  
cat. B



**C428 azul**  
cat. D



**C429 papaya**  
cat. C

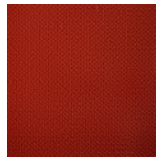

**C430 cotta**  
cat. E

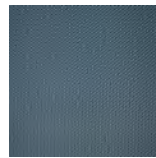

**C432 petrol**  
cat. C

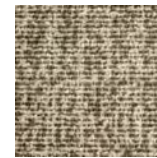

**C434 turtle**  
cat. C

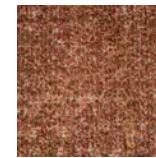

**C436 amaretto**  
cat. C



**C438 matcha**  
cat. D



**C439 ray**  
cat. D



**C440 scarlett**  
cat. B



**C441 wave**  
cat. D



**C442 peacock**  
cat. C

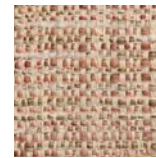

**C445 bubblegum**  
cat. C



**C446 seaweed**  
cat. C

More technical details about our fabrics can be found on [www.jardinico.com](http://www.jardinico.com).



# MATERIALS

## CERAMIC - CÉRAMIQUE - KERAMIEK frame



K02 bianco

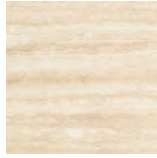

K12 earth



K14 taupegrey

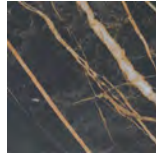

K31 charcoal

Made of natural clays and mineral colours which are pressed and fired to make a high-performing surface. Thickness of 12 mm, 0,5".

## MINERAL STONE frame



X01 mist

A mixture of chalk and concrete applied by hand and spatula. Silky texture, water-repellent & waterproof.

## WICKER frame



F16 cottage



R32 black

High quality, synthetic fibre that is woven by hand. UV-resistant, resistant to great variations in temperature. Sea- & chlorine water repellent, scratch resistant.

## WOOD frame

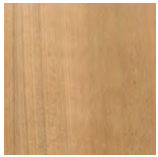

W62 teak

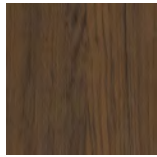

W64 sable teak

W62: teak with matt finish.  
W64: teak with brushed finish and coloured coating

## ROPE frame - structure



R03 linen



R04 almond



R05 seal

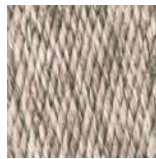

R11 artichoke

UV-resistant polyolefin, woven by hand.

# MATERIALS

## **SYNTHETIC LEATHER** only available for Bolsa & Bay

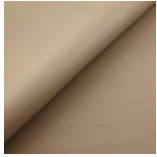

L003 frappé  
cat. C



L401 celadon  
cat. C

81% PVC, 19% CO, weather & UV resistant.

## **PIPING** only available for Bolsa & Bay



Y08 biarritz

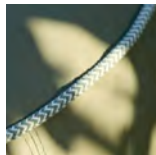

Y41 blade

Weather & UV resistant acrylic.

## **ALUMINIUM** frame

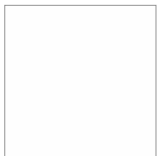

A01 white



A03 linen

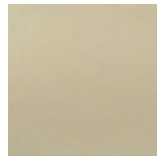

A04 almond



A14 lava

Powdercoated aluminium.

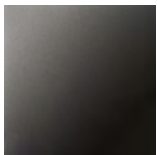

A31 charcoal



A32 black



jardinico<sup>®</sup>

Event Selection s.r.o.  
showroom Nádražní 20,  
Roztoky u Prahy  
+420 602 410 657

[vitek@eventselection.cz](mailto:vitek@eventselection.cz)  
[www.eventselection.cz](http://www.eventselection.cz)









